



elektimo

Kalite en iyi pazarlamacıdır

2022-1

ÜRÜN KATALOĞU

since 1981

SPİRAL REZİSTANSLAR ve CAMLI (QUARTZ) REZİSTANS ÇEŞİTLERİ TYPES OF SPIRAL RESISTANCE AND GLASS (QUARTZ) RESISTANCE

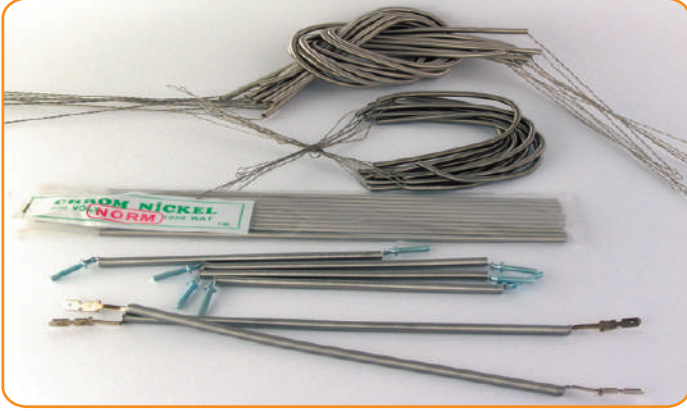

SPİRAL REZİSTANSLAR (PİYASA) SPIRAL RESISTANCE (MARKET)

KOD	ADET	CİNSİ	FİYAT
CR 101 151	10 Ad.	800 W. Ocak Spirali	0.35 \$
CR 101 152	10 Ad.	1000 W. Ocak Spirali	0.37 \$
CR 101 153	10 Ad.	1200 W. Ocak Spirali	0.40 \$
CR 101 154	10 Ad.	1500 W. Ocak Spirali	0.42 \$
CR 101 156	10 Ad.	2000 W. Ocak Spirali	0.48 \$
CR 101 158	10 Ad.	2500 W. Ocak Spirali	0.50 \$
CR 101 160	10 Ad.	800 W. Fırın Spirali	0.85 \$
CR 101 161	10 Ad.	1000 W. Fırın Spirali	0.95 \$
CR 101 162	10 Ad.	1200 W. Fırın Spirali (Karabük)	1.40 \$
CR 101 163	10 Ad.	1500 W. Fırın Spirali (Karabük)	1.60 \$
CR 101 164	10 Ad.	500 W. Cam Spirali	0.45 \$
CR 101 165	10 Ad.	600 W. Cam Spirali	0.45 \$
CR 101 167	10 Ad.	700 W. Cam Spirali	0.45 \$
CR 101 168	10 Ad.	800 W. Cam Spirali	0.50 \$
CR 101 169	10 Ad.	1000 W. Cam Spirali	0.55 \$
CR 101 171	10 Ad.	500 W. 110V. Seri Cam Spirali	0.50 \$

SPİRAL REZİSTANSLAR (NORM) SPIRAL RESISTANCE (NORM)

KOD	ADET	CİNSİ	FİYAT
CR 102 151	10 Ad.	800 W. Ocak Spirali	2.25 \$
CR 102 152	10 Ad.	1000 W. Ocak Spirali	2.50 \$
CR 102 153	10 Ad.	1200 W. Ocak Spirali	3.00 \$
CR 102 154	10 Ad.	1500 W. Ocak Spirali	3.60 \$
CR 102 156	10 Ad.	2000 W. Ocak Spirali	4.50 \$
CR 102 160	10 Ad.	800 W. Fırın Spirali	2.50 \$
CR 102 161	10 Ad.	1000 W. Fırın Spirali	2.90 \$
CR 102 162	10 Ad.	1200 W. Fırın Spirali (Karabük)	5.50 \$
CR 102 163	10 Ad.	1500 W. Fırın Spirali (Karabük)	7.50 \$
CR 102 164	10 Ad.	500 W. Cam Spirali	1.25 \$
CR 102 165	10 Ad.	600 W. Cam Spirali	1.25 \$
CR 102 167	10 Ad.	700 W. Cam Spirali	1.25 \$
CR 102 168	10 Ad.	800 W. Cam Spirali	1.25 \$
CR 102 169	10 Ad.	1000 W. Cam Spirali	1.50 \$
CR 102 171	10 Ad.	500 W. 110V. Seri Cam Spirali	1.25 \$

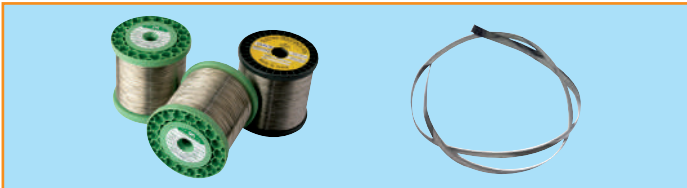

CR 103 151	Rezistans Teli (25/5) (Cr-AL) 1 Kg.	25.00 \$
CR 103 171	Rezistans Teli (30/20) (Cr-Ni) 1 Kg.	115.00 \$
CR 103 181	Yassı Rezistans Teli 1 Kg. (25/5) (Cr-AL)	100.00 \$
CR 103 191	1 mt. Yassı Rezistans Teli (25/5) (Cr-AL)	2.20 \$

İNFRARED SOBA SPİRAL REZİSTANSLAR (PİYASA)

KOD	WATT	CİNSİ	FİYAT
CR 104 100	1000W.	İnfrared Soba Spirali	1.50 \$
CR 104 101	1200W.	İnfrared Soba Spirali	1.50 \$
CR 104 103	1500W.	İnfrared Soba Spirali	1.60 \$
CR 104 105	1800W.	İnfrared Soba Spirali	1.70 \$
CR 104 107	2000W.	İnfrared Soba Spirali	1.80 \$
CR 104 109	2500W.	İnfrared Soba Spirali	2.00 \$
CR 104 111	3000W.	İnfrared Soba Spirali	2.35 \$

İNFRARED SOBA SPİRAL REZİSTANSLAR (NORM)

KOD	WATT	CİNSİ	FİYAT
CR 105 100	1000W.	İnfrared Soba Spirali	3.00 \$
CR 105 101	1200W.	İnfrared Soba Spirali	3.10 \$
CR 105 103	1500W.	İnfrared Soba Spirali	3.50 \$
CR 105 105	1800W.	İnfrared Soba Spirali	3.65 \$
CR 105 107	2000W.	İnfrared Soba Spirali	3.80 \$
CR 105 109	2500W.	İnfrared Soba Spirali	4.20 \$
CR 105 111	3000W.	İnfrared Soba Spirali	5.00 \$

İNFRARED SOBA İÇİN KOMPLE CAMLI REZ. KALINLIK 23 mm. (PİYASA)

KOD	CİNSİ	FİYAT
CR 106 141	65cm-90cm. Komple Camlı Rez. (1000-3000W Arası)	7.00 \$

İNFRARED SOBA İÇİN KOMPLE CAMLI REZ. KALINLIK 23 mm. (NORM)

KOD	CİNSİ	FİYAT
CR. 107 151	65cm-90cm. Komple Camlı Rez. (1000-3000W Arası)	10.00 \$

İNFRARED SOBANIN BOŞ CAMLARI (KALINLIK 23 mm.)

KOD	CİNSİ	FİYAT
CR 108 151	50 - 55 - 60 - 65 - 70 - 75 - 80	2.30 \$
CR 108 152	90 cm.	2.20 \$
CR 108 161	250 cm.	5.50 \$

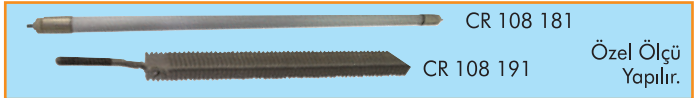

MİKATRONİK REZİSTANSLAR (Cam boyu geçerlidir)

KOD	CİNSİ	FİYAT
CR 108 181	50-55-60-65cm. Mikatronik Komple Camlı Rez.	7.00 \$
CR 108 191	50-55-60-65cm. Mikatronik Camsız Rezistans	5.50 \$
CR 108 195	65cm. Orbit Camlı Rezistans	13.00 \$

HALOJEN KARBON CAM REZİSTANS

KOD	CİNSİ	FİYAT
CR 108 201	42 - 55 - 61,5 - 75 cm. Mutlaka ölçü belirtiniz	30.00 \$



İNCE (10 mm) CAMLI REZİSTANSLAR

KOD	CİNSİ	FİYAT
CR. 109 151	Camlı Rezistans (50 Ad.) (35-37.5-40 cm) (10 mm.) (1 No)	0.90 \$
CR. 109 171	Camlı Rezistans (50 Ad.) (42-44-50-55-57-61.5 cm) (1 No)	1.10 \$
CR. 109 181	10 mm Boş İnce Cam (40-61.5 cm)	0.75 \$
CR. 109 191	10 mm Boş İnce Cam (250 cm)	1.30 \$
CR. 109 199	İhlas Tipi Camlı Rezistans (10 Ad.) (2'li 27 cm) (No. 3)	2.00 \$

ŞOFBEN ve TERMOSİFON REZİSTANSLARI

GEYSER AND THERMOSIPHON HEATERS



CR 110 099
Bakır İhlas Şofben Rezistansı
220V. 7500W. (6.5 Ø-Cu)

25.00 \$



CR 110 101
İhlas Şofben Rezistansı
220V. 7000W. (6.5 Ø-Cr-ni)

9.50 \$



CR 110 102
Şofben Rezistansı
220V. 7000W. (6.5 Ø-Cr-ni)

12.50 \$



CR 110 103
Arçelik Şofben Rezistansı
220V. 7000W. (6.5 Ø-Cr-ni)

12.50 \$



CR 110 104
Şofben Rezistansı (Tekli)
220V. 4000W. (6.5 Ø-Cr-ni)

7.20 \$



CR 110 105
Kısa Mutfak Şofben Rez.
220V. 5500W. (6.5 Ø-Cr-ni)

10.00 \$



CR 110 106
Veito Banyo Şofben Rez.
220V. 7000W. (6.5 Ø-Cr-ni)

10.50 \$



CR 110 107
Delikli Kısa Mutfak Rezistansı
220V. 5500W. (6.5 Ø-Cr-ni)

11.00 \$



CR 110 115
Arçelik Bakır İki Elemanlı Şofben Rez.
220V. 4000W.+4000W

18.50 \$



CR 110 219
Bakır G5 Termosifon Rezistansı
220V. 2000W. (8.5 Ø-Cu)

14.00 \$



CR 110 221
G5 Demirdöküm Term. Rez.
230V. 2000W (8.5 Ø-Cr-ni)

11.50 \$



CR 110 222
G5 Demirdöküm Term. Rez.
220V. 2000W (8.5 Ø-Cr-ni)

16.00 \$



CR 110 223
Baymak Şofben Rezistansı
220V. 2000W. (8.5 Ø-Cr-ni)

11.00 \$



CR 110 224
Baymak Şofben Rezistansı (Düz)
220V. 2000W. (8.5 Ø-Cr-ni)

11.00 \$



CR 110 225
Termosifon Rezistansı
220V. 1950W. (8.5 Ø-Cr-ni)

11.00 \$



CR 110 226
Süsler Çift Termik Delikli
Termosifon Rezistansı
220V. 1950W. (8.5 Ø-Cr-ni)

15.00 \$



CR 110 227
Arçelik Titanyum Rezistans Flanşı
6 Delikli

2.50 \$



CR 110 228
Arçelik Titanyum Termosifon
Rez. (Flanşlı) 220V. 2000W.
(8.5 Ø-Cr-ni)

16.50 \$



CR 110 229
Arçelik Titanyum Termosifon
Rez. (Flanşsız) 220V. 2000W.
(8.5 Ø-Cr-ni)

11.00 \$



CR 110 230
ECA Termosifon Rezistansı
220V. 2000 W. (8.5 Ø-Cr-ni)

11.00 \$

ŞOFBEN ve TERMOSİFON REZİSTANSLARI

GEYSER AND THERMOSIPHON HEATERS



CR 110 232

Titanium Rezistans Flanşı
5 Delikli

2.50 \$



CR 110 233

Ariston Termosifon Rezistansı
220V. 2000W. (8.5Ø-Cu-Bakır)

12.50 \$



CR 110 234

Çıkıntılı Ariston Bakır Rezistansı
220V. 2000W. (8.5Ø-Cu)

12.50 \$



CR 110 237

Bakır G5 Flanşlı Ariston
Termosifon Rezistansı
220V. 2000 W. (8.5 Ø-Cu)

25.00 \$



CR 110 242

Bakır Arçelik Titanium
Termosifon Rezistansı (6 Delikli)
220V. 2000 W. (8.5 Ø-Cu)

20.00 \$

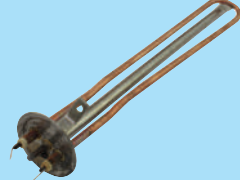

CR 110 245

Bakır Arçelik Titanium
Termosifon Rezistansı (6 Delikli)
220V. 2000 W. (8.5 Ø-Cu)

14.00 \$



CR 110 247

Arçelik Titanium Krom
Rezistansı Porselen Başlıklı
220V. 2000 W. (8.5 Ø-Cr-ni)

12.00 \$

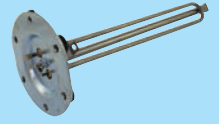

CR 110 250

Vestel Titanium
Termosifon Rezistansı
220V. 2000 W. (8.5 Ø-Cr-ni)

20.00 \$

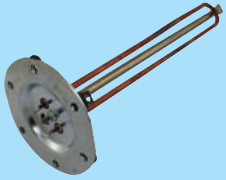

CR 110 251

Bakır Vestel Titanium
Termosifon Rezistansı (6 Delikli)
220V. 2000 W. (8.5 Ø-Cu)

24.00 \$

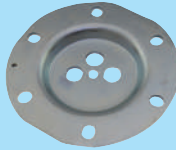

CR 110 252

Vestel Termosifon
Rezistansı Flanşı
(6 Delikli)

8.50 \$



CR 110 255

Termosifon Rezistansı
(5 Delikli)
220V. 2000 W. (8.5 Ø-Cr-ni)

16.00 \$



CR 110 260

Bakır 5 Delikli
Termosifon Rezistansı
220V. 2000 W. (8.5 Ø-Cu-Bakır)

28.00 \$



CR 110 265

Yuvarlak Flanşlı Çift Ter. Borulu
Termosifon Rezistansı İki Elemanlı
220V. 2000 W. (8.5 Ø-Cr-ni)

11.00 \$



CR 110 266

Bakır Yuvarlak Flanşlı Çift Ter. Borulu
Termosifon Rezistansı İki Elemanlı
220V. 2000 W. (8.5 Ø-Cu)

19.00 \$



CR 110 270

Yuvarlak Flanşlı
Termosifon Rezistansı İki Elemanlı
220V. 700 W. (8.5 Ø-Cr-ni)

8.00 \$



CR 110 275

Bakır Yuvarlak Flanşlı
Termosifon Rezistansı İki Elemanlı
220V. 700 W. (8.5 Ø-Cu)

12.50 \$



CR 110 281

Bakır Çift Termostat (Tek Eleman)
Borulu Termosifon Rezistansı
220V. 1300 W. (8.5 Ø-Cu)

13.00 \$



CR 110 283

Krom Çift Termostat (Tek Eleman)
Borulu Termosifon Rezistansı
220V. 1300 W. (8.5 Ø-Cr-ni)

11.00 \$

CR 111 101



CR 111 102

Kireç Tutucu Anot
CR 111 101 Boy 260 mm - Çap : 22 mm (Kalın) 8.00 \$
CR 111 102 Boy 250 mm - Çap : 17 mm (İnce) 5.00 \$

SEMAVER REZİSTANSLARI

SAMOVAR HEATERS



CR 112 101

Semaver Rezistansı
220V. 1000W. (8.5 Ø-Cr-ni)

7.00 \$

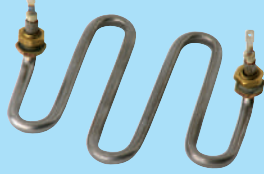

CR 112 103

Semaver Rezistansı
220V. 1500W. (8.5 Ø-Cr-ni)

8.00 \$

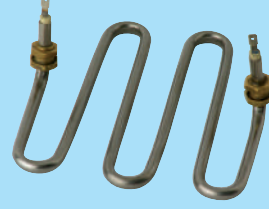

CR 112 105

Semaver Rezistansı
220V. 2000W. (8.5 Ø-Cr-ni)

8.50 \$

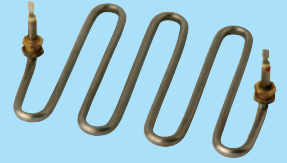

CR 112 107

Semaver Rezistansı
220V. 2500W. (8.5 Ø-Cr-ni)

9.00 \$



CR 112 121

İnce Semaver Rezistansı
220V. 1000W. (6.5 Ø-Cr-ni)

7.00 \$

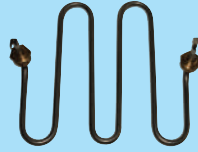

CR 112 123

İnce Semaver Rezistansı
220V. 1500W. (6.5 Ø-Cr-ni)

8.00 \$



CR 112 125

İnce Semaver Rezistansı
220V. 2000W. (6.5 Ø-Cr-ni)

8.50 \$

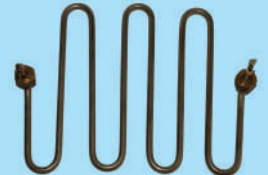

CR 112 127

İnce Semaver Rezistansı
220V. 2500W. (6.5 Ø-Cr-ni)

9.00 \$

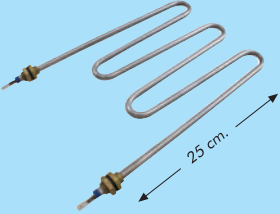

CR 112 131

Semaver Rezistansı
220V. 2000W. (8.5 Ø-Cr-ni)

11.00 \$

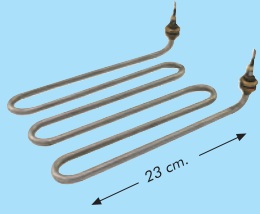

CR 112 135

Semaver Rezistansı
220V. 2000W. (8.5 Ø-Cr-ni)

11.00 \$

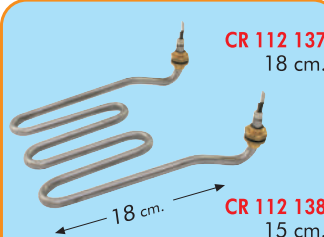

CR 112 137
18 cm.

CR 112 138
15 cm.

Semaver Rezistansı - Kıvrık
220V. 2000W. (8.5 Ø-Cr-ni)

11.00 \$

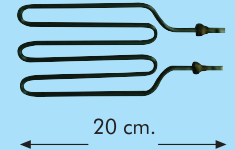

CR 112 140

Semaver Rezistansı
220V. 2000W. (8.5 Ø-Cr-ni)

11.00 \$

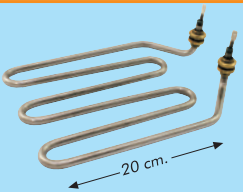

CR 112 149

Semaver Rezistansı
220V. 2000W. (8.5 Ø-Cr-ni)

11.00 \$

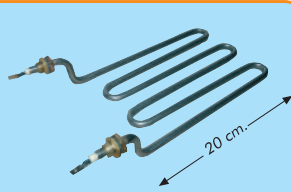

CR 112 155

Ördek Kafa Semaver Rezistansı
220V. 2000W. (8.5 Ø-Cr-ni)

11.00 \$

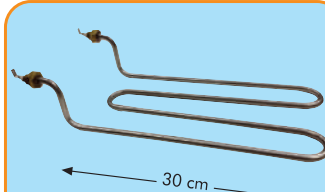

CR 112 161

Ördek Kafa Semaver Rezistansı
220V. 2000W. (8.5 Ø-Cr-ni)

11.00 \$

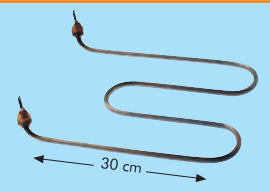

CR 112 167

Semaver Rezistansı - Kıvrık
220V. 2000W. (8.5 Ø-Cr-ni)

11.00 \$

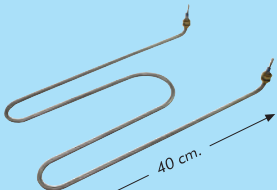

CR 112 169

Semaver Rezistansı - Kıvrık
220V. 2500W. (8.5 Ø-Cr-ni)

15.50 \$

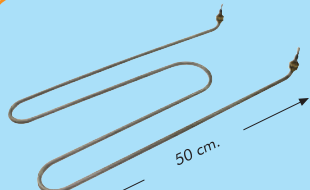

CR 112 171

Semaver Rezistansı - Kıvrık
220V. 2500W. (8.5 Ø-Cr-ni)

16.50 \$

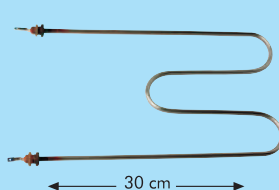

CR 112 173

Semaver Rezistansı
220V. 2000W. (8.5 Ø-Cr-ni)

11.00 \$

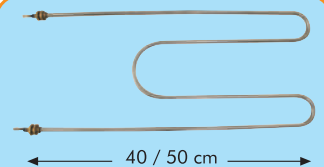

Semaver Rezistansı
220V. 2500W. (8.5 Ø-Cr-ni)

CR 112 175 40 cm. 15.50 \$

CR 112 177 50 cm. 17.50 \$

SEMAVER REZİSTANLARI

SAMOVAR HEATERS

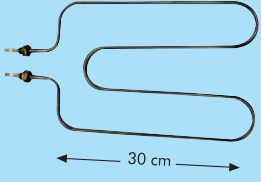

CR 112 179

Semaver Rezistansı
220V. 2000W. (8.5 Ø-Cr-ni)

15.00 \$

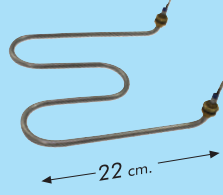

CR 112 181

Semaver Rezistansı - Kıvrık
220V. 2000W. (8.5 Ø-Cr-ni)

10.00 \$

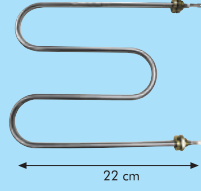

CR 112 185

Semaver Rezistansı Düz
220V. 2000W. (8.5 Ø-Cr-ni)

11.00 \$

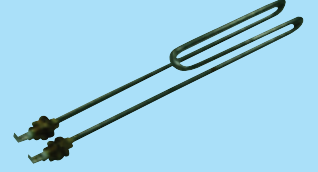

CR 112 201

Rekorlu Pot Isıtıcı
220V. 2000W. (8.5 Ø-Cr-ni)

11.00 \$

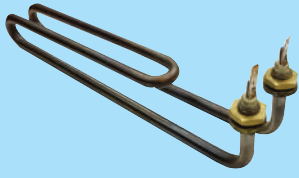

CR 112 205

Eğri Rekorlu Pot Isıtıcı
220V. 2000W. (8.5 Ø-Cr-ni)

11.00 \$

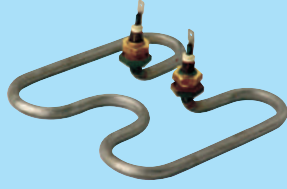

CR 112 211

Semaver Rezistansı
220V. 1500W. (8.5 Ø-Cr-ni)

11.00 \$

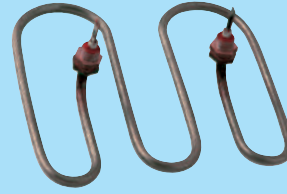

CR 112 215

Semaver Rezistansı
220V.1500W. (8.5 Ø-Cr-ni)

11.00 \$

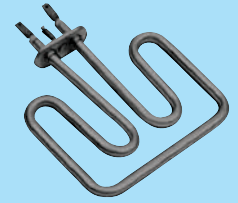

CR 112 217

Semaver Rezistansı
220V. 1200W. (8.5 Ø-Cr-ni)

11.00 \$

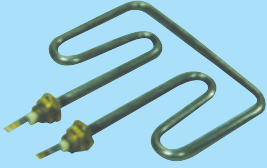

CR 112 219

Semaver Rezistansı
220V.1200W. (8.5 Ø-Cr-ni)

11.00 \$



CR 112 225

Semaver Rezistansı
220V.1000W. (8.5 Ø-Cr-ni)

10.00 \$



CR 112 227

Semaver Rezistansı
220V.1000W. (8.5 Ø-Cr-ni)

10.00 \$



CR 112 229

Semaver Rezistansı
220V.1650W. (8.5 Ø-Cr-ni)

13.00 \$



CR 112 235

Semaver Rezistansı
220V.500W. (8.5 Ø-Cr-ni)

13.00 \$



CR 112 236

Semaver Rezistansı
220V.1500W. (8.5 Ø-Cr-ni)

11.50 \$



CR 112 238

Semaver Rezistansı
220V.2000W. (8.5 Ø-Cr-ni)

13.00 \$



CR 112 245

Semaver Rezistansı
220V.1500W. (8.5 Ø-Cr-ni)

11.00 \$

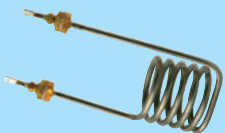

CR 112 251

Semaver Rezistansı
230V.2000W. (6.5 Ø-Cr-ni)

12.50 \$



CR 112 261

Semaver Rezistansı
220V.2500W. (6.5 Ø-Cr-ni)

11.00 \$

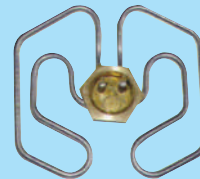

CR 112 265

Rekorlu Semaver Rezistansı
220V.2500W. (6.5 Ø-Cr-ni)

18.00 \$

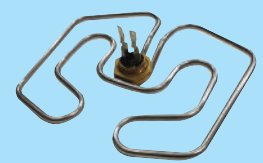

CR 112 271

Küçük Rekorlu Sem. Rez.
220V.2500W. (6.5 Ø-Cr-ni)

17.00 \$

SEMAVER REZİSTANLARI

SAMOVAR HEATERS



CR 112 281
Rekorlu Semaver Rezistansı
220V.3000W. (8.5 Ø-Cr-ni)

28.00 \$



CR 112 285
Tek Elemanlı Rekorlu Semaver Rez.
230V. 1500W. (8.5 Ø-Cr-ni)

21.00 \$



Rekorlu Semaver Rezistansı
220V.1400W. (8.5 Ø-Cr-ni) **CR 112 291** 16.00 \$
Rekorlu Semaver Rezistansı
220V.1700W. (8.5 Ø-Cr-ni) **CR 112 295** 16.00 \$
Rekorlu Semaver Rezistansı
220V.2400W. (8.5 Ø-Cr-ni) **CR 112 298** 16.00 \$



Semaver Rezistansı **CR 112 305**
220V.2000W. (8.5 Ø-Cr-ni) 30.00 \$
Semaver Rezistansı **CR 112 307**
220V.3500W. (8.5 Ø-Cr-ni) 30.00 \$



Kelebek Rezistans **CR 112 321** Kelebek Rez. 220V. 1400W. 8.70 \$
Yonca Rezistans **CR 112 324** Kelebek Rez. 220V. 1750W. 9.50 \$
CR 112 327 Kelebek Rez. 220V. 2200W. 10.00 \$
CR 112 329 Kelebek Rez. 220V. 2750W. 11.00 \$
CR 112 333 Yonca Rez. 220V. 2750W. 12.50 \$



CR 112 350
Semaver Rezistansı
220V. 2500W. (8.5 Ø-Cr-ni)

34.00 \$



CR 112 351
Semaver Rezistansı
220V. 3200W. (8.5 Ø-Cr-ni)

40.00 \$



CR 112 501
Döküm Semaver Rezistansı
220V. 1100W. (Cr-ni/Alüminyum)

8.50 \$



CR 112 502
Armağan Döküm Semaver Rezistansı
220V. 1100W. (Cr-ni/Alüminyum)

8.50 \$



CR 112 505
Küçük Döküm Semaver Rezistansı
220V. 1100W. (Cr-ni/Alüminyum)

8.50 \$



CR 112 525
Isı Silikonu (Döküm Semaver vb.
Rez. Gövdeye Temasında Kullanılır.)

2.60 \$



CR 112 527
Isı Silikonu (Döküm Semaver vb.
Rez. Gövdeye Temasında Kullanılır.)
1 kg.

60.00 \$



CR 112 530
Kahve Makinası Rezistansı
220V. 1400W.
(Cr-ni-Alüminyum)

14.00 \$



CR 112 535
Gizli Çevre Rezistansı
220V. 700W.
Çap : 95mm (6 Delikli)

14.00 \$



CR 112 536
Gizli Semaver Rezistansı
220V. 1250W. Çap : 100mm

14.00 \$



CR 112 537
Gizli Semaver Rezistansı
(Armağan)
220V. 1500W. Çap : 140mm

16.00 \$



CR 112 538
Gizli Semaver Rezistansı
(Armağan)
220V. 2000W. Çap : 160mm

16.00 \$



CR 112 539
Gizli Semaver Rezistansı
(Armağan)
220V. 2000W. Çap : 160mm

16.00 \$



CR 112 540
Çift Elemanlı
Gizli Semaver Rez.
220V. 2000W. Çap : 160mm

19.00 \$



Gizli Semaver Rez. **CR 112 541**
220V. 1000W. Çap : 140mm 16.00 \$
Conta **CR 112 542** 1.00 \$



Gizli Semaver Rez. **CR 112 543**
220V. 2000W. Çap : 165mm 16.00 \$
Conta **CR 112 544** 1.20 \$



Gizli Semaver Rezistansı
220V. 1000W.
CR 112 547 130 mm (4 Delikli)
CR 112 548 160 mm (4 Delikli)

16.00 \$

SEMAVER REZİSTANSLARI

SAMOVAR HEATERS



CR 112 549 ← 8 cm →
Nargile Rezistansı
220V. 600W. (6.5 Ø-Cr-ni)

3.50 \$



CR 112 550 ← 8 cm →
Semaver Rezistansı (Kuru)
220V. 700W. (6.5 Ø-Cr-ni)

4.00 \$



CR 112 552 ← 14 cm →
Borulu Ocak Rezistansı (Kuru)
220V.1000W. (6.5 Ø-Cr-ni)

4.50 \$



CR 112 555 ← 8 cm →
Semaver Rezistansı Rekorlu
220V.1500W. (6.5 Ø-Cr-ni)

8.00 \$



CR 112 701
İran Semaver Rezistansı (Flanşlı)
220V.1000W.

6.00 \$



CR 112 705
İran Rekorlu Semaver Rezistansı
220V.1000W.

6.00 \$



CR 112 801
Ketil Rezistansı
220V.2000W.

3.65 \$



CR 112 802
Ters Ketil Rezistansı
220V.-2000W

3.65 \$



CR 112 803
Çanaklı Ketil Rezistansı
220V.-2000W

3.65 \$



CR 112 804
Arçelik Ketil Rezistansı
220V.-2000W

3.65 \$



CR 112 805
Arçelik Ters Ketil Rez.
220V.-2000W

3.65 \$

(1Cm=10W)

6.5 Ø-Cr-ni
Krom Boru Rez.

CR 112 901	30-40-50 cm.	2.50 \$
CR 112 905	60-70-80 cm.	3.00 \$
CR 112 910	90-100-110 cm.	4.00 \$
CR 112 915	120-130-140 cm.	4.80 \$
CR 112 921	150-160-170 cm.	5.50 \$
CR 112 926	180-190-200 cm.	7.00 \$

(1Cm=10W)

8.5 Ø-Cr-ni Krom Boru Rez.

CR 112 951	30-40-50 cm.	4.00 \$	CR 112 981	180-190-200 cm.	10.00 \$
CR 112 956	60-70-80 cm.	5.00 \$	CR 112 985	210-220-230 cm.	11.00 \$
CR 112 961	90-100-110 cm.	6.00 \$	CR 112 991	240-250-260 cm.	12.00 \$
CR 112 967	120-130-140 cm.	7.50 \$	CR 112 995	270-280-290 cm.	14.00 \$
CR 112 972	150-160-170 cm.	8.50 \$	CR 112 998	300 cm.	15.00 \$

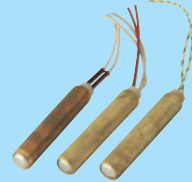

Fişek Rezistanslar
(220V.60W-75W.) CR 113 101 13.00 \$
Fişek Rezistanslar CR 113 121
12V. -220V. (75W.) 4 Çıkışlı 22.00 \$

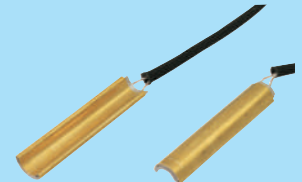

CR 113 124
Oval Fişek Rezistanslar
220V.-75W

13.00 \$

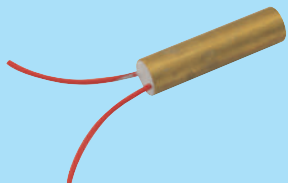

CR 113 125
Pano Fişek Rezistanslar
220V.-100W Boy:65 mm Çap:16mm

7.50 \$



CR 113 151
Pano Rezistansı (220V.100W)

7.50 \$

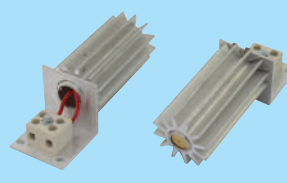

CR 113 155
Fişekli Pano Rezistansı
(Değişebilir Fişek Rez.) 220V.-100W

13.00 \$

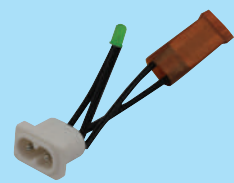

CR 113 181
Ağda Rezistansı

6.00 \$

FIRIN BORU REZİSTANLARI

OVEN TUBE HEATERS

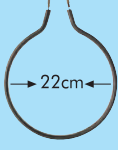

CR 114 101

Mini Fırın Boru Rez.
(Ampul Soketli)
220V.700W (11.5 Ø-Demir)

1.50 \$

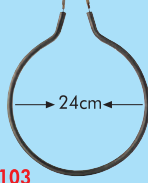

CR 114 103

Orta Fırın Boru Rez. (Ampul Soketli)
220V.750W. (11.5 Ø-Demir)

1.50 \$

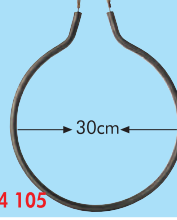

CR 114 105

Büyük Fırın Boru Rez. (Ampul Soketli)
220V.800W. (11.5Ø-Demir)

1.50 \$

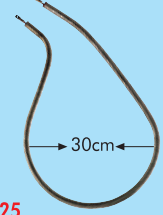

CR 114 125

Fırın Boru Rezistansı (Mide-Soketli)
220V. 650W. (11.5Ø-Demir)

1.50 \$

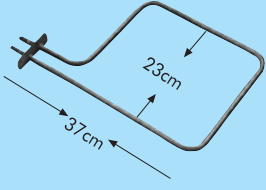

CR 114 135

İnce Fırın Boru Rez. (Köşeli-Flanşlı)
220V. 1000W. (6.5 Ø-Cr-ni)

5.50 \$

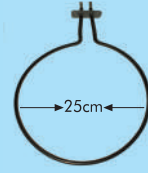

CR 114 138

İnce Fırın Boru Rez. (Flanşlı)
220V. 800W. (6.5 Ø-Cr-ni)

5.50 \$

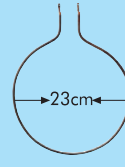

CR 114 140

Mini İnce Fırın Boru Rez. (Ampul)
220V. 700W. (6.5 Ø-Cr-ni)

4.50 \$

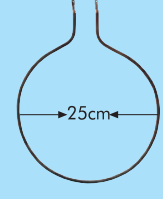

CR 114 142

Orta İnce Fırın Boru Rez. (Ampul)
220V. 750W. (6.5 Ø-Cr-ni)

5.50 \$

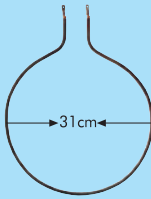

CR 114 144

Büyük İnce Fırın Boru Rez. (Ampul)
220V. 1000W. (6.5 Ø-Cr-ni)

5.50 \$

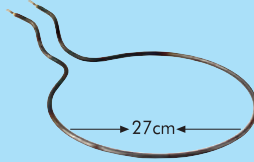

CR 114 146

Büyük İnce Fırın Boru Rez. (Ampul)
220V. 1000W. (6.5 Ø-Cr-ni)

6.00 \$

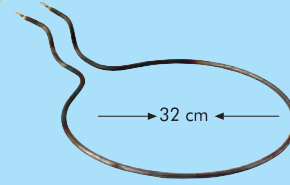

CR 114 147

İnce Fırın Rez. (Ördek Kafa)
220V.750W (6.5 Ø-Cr-ni)

6.00 \$

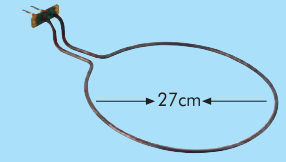

CR 114 150

İnce Fırın Rez. (Ördek Kafa-Flanşlı)
220V.750W (6.5 Ø-Cr-ni)

6.00 \$

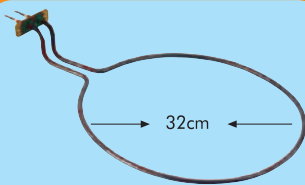

CR 114 152

İnce Fırın Rez. (Ördek Kafa-Flanşlı)
220V.750W (6.5 Ø-Cr-ni)

6.00 \$

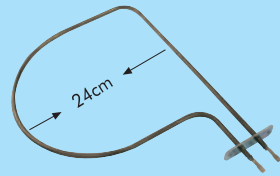

CR 114 154

Flanşlı İnce Fırın Rezistansı (Mide)
220V. 1000W (6.5 Ø-Cr-ni)

6.00 \$

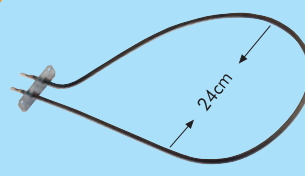

CR 114 156

İnce Fırın Rezistansı (Mide-Flanşlı)
220V.650W (6.5 Ø-Cr-ni)

6.00 \$

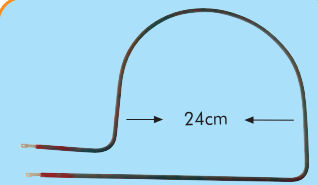

CR 114 158

İnce Fırın Rezistansı (Mide)
220V.1000W (6.5 Ø-Cr-ni)

6.00 \$

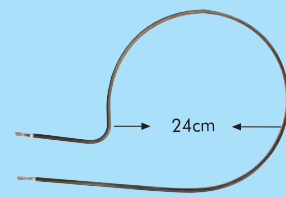

CR 114 160

İnce Fırın Rezistansı (Mide)
220V.650W (6.5 Ø-Cr-ni)

6.00 \$

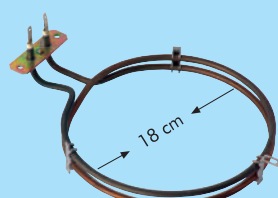

CR 114 251

Turbo Fırın Rezistansı
220V.2500W. (6.5 Ø-Cr-ni)

7.00 \$

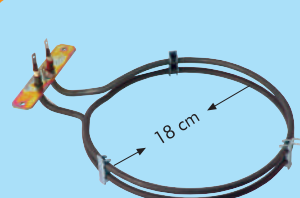

CR 114 252

Turbo Fırın Rezistansı
220V.2600W. (6.5 Ø-Cr-ni)

7.00 \$

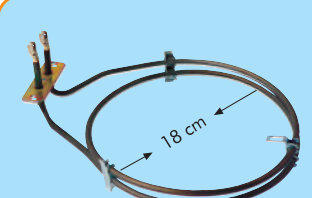

CR 114 253

Turbo Fırın Rezistansı
220V.2250W. (6.5 Ø-Cr-ni)

7.00 \$

FIRIN BORU REZİSTANSLARI

OVEN TUBE HEATERS

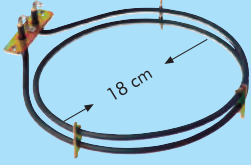

CR 114 254
Turbo Fırın Rezistanı
220V.2500W. (6.5 Ø-Cr-ni)

7.00 \$



CR 114 255
Turbo Fırın Rezistanı - 3 Boğumlu
220V.2500W. (6.5 Ø-Cr-ni)

10.00 \$

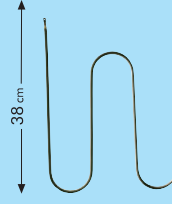

CR 114 291
(M) Tipi Fırın Boru Rezistanı
220V.750W. (6.5 Ø-Cr-ni)

6.00 \$

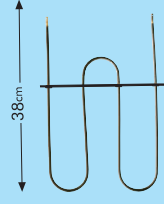

CR 114 293
(M) Tipi Fırın Boru Rezistanı
220V.1000W. (6.5 Ø-Cr-ni)

6.50 \$

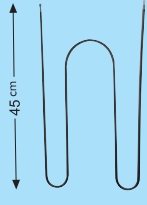

CR 114 295
(M) Tipi Fırın Boru Rez. (KUMTEL)
220V.1000W. (6.5 Ø-Cr-ni)

7.50 \$

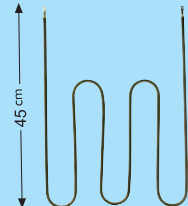

CR 114 305
Fırın Boru Rezistanı
220V. 1000W. (6.5 Ø-Cr-ni)

8.00 \$

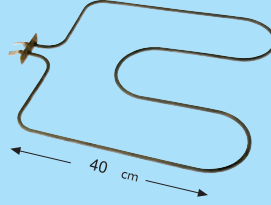

CR 114 325
Fırın Boru Rezistanı
220V. 1200W. (6.5 Ø-Cr-ni)

7.50 \$

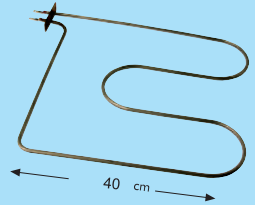

CR 114 329
Fırın Boru Rezistanı
220V. 750W. (6.5 Ø-Cr-ni)

7.50 \$

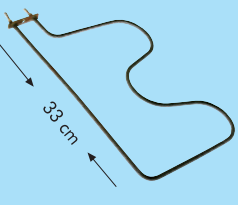

CR 114 335
Fırın Boru Rezistanı
230V. 650W. (6.5Ø-Cr-ni)

6.50 \$

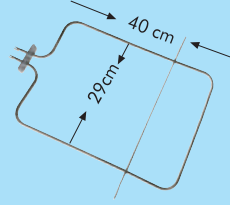

CR 114 341
Fırın Boru Rezistanı
220V. 1200W. (6.5Ø-Cr-ni)

7.50 \$

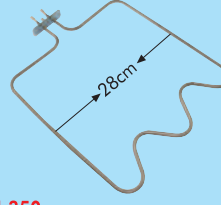

CR 114 350
Küçük Fırın Boru Rezistanı
220V. 1200W. (6.5Ø-Cr-ni)

7.00 \$

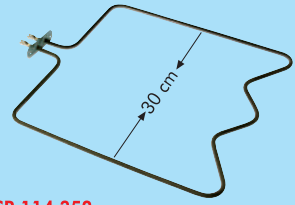

CR 114 352
Fırın Boru Rezistanı
220V. 1350W. (6.5 Ø-Cr-ni)

7.50 \$

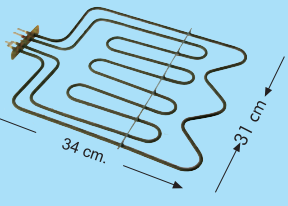

CR 114 354
Fırın Boru Rezistanı
220V. 3500W. (6.5 Ø-Cr-ni)

16.00 \$

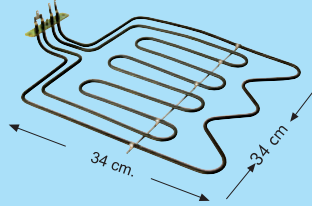

CR 114 356
Fırın Boru Rezistanı
220V. 3500W. (6.5 Ø-Cr-ni)

16.00 \$

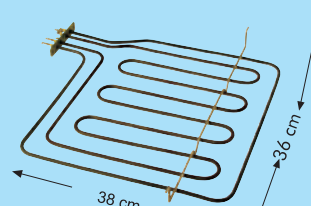

CR 114 358
Fırın Boru Rezistanı
220V. 3500W. (6.5 Ø-Cr-ni)

15.00 \$

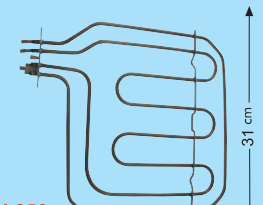

CR 114 359
Küçük Fırın Boru Rezistanı
230V. 3000W. (6.5 Ø-Cr-ni)

15.00 \$

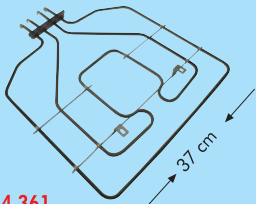

CR 114 361
Arçelik Fırın Rezistanı
220V. 2800W. (6.5 Ø-Cr-ni)

16.00 \$

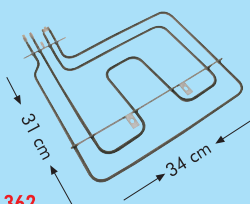

CR 114 362
Arçelik Fırın Rezistanı
220V. 2200W. (6.5 Ø-Cr-ni)

11.00 \$

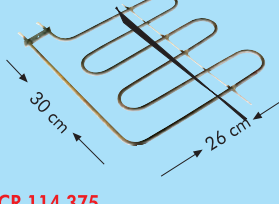

CR 114 375
Mini Arçelik Fırın Boru Rez.
220V. 2000W. (6.5 Ø-Cr-ni)

9.00 \$

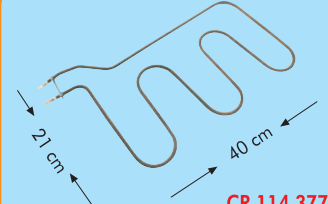

CR 114 377
Arçelik Fırın Rezistanı
220V. 1500W. (6.5 Ø-Cr-ni)

8.00 \$

FIRIN BORU REZİSTANSLARI OVEN TUBE HEATERS

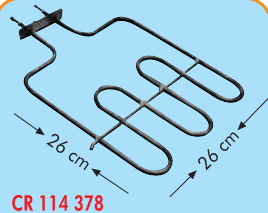

CR 114 378

Fırın Boru Rezistansı
220V. 1300W. (6.5 Ø-Cr-ni)

9.00 \$

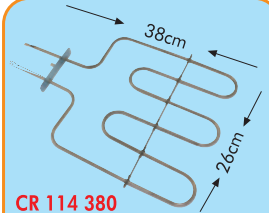

CR 114 380

Fırın Boru Rezistansı
220V. 1300W. (6.5 Ø-Cr-ni)

9.00 \$

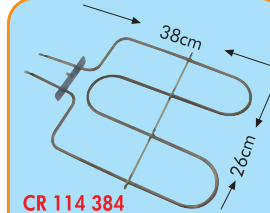

CR 114 384

Fırın Boru Rezistansı
220V. 1300W. (6.5 Ø-Cr-ni)

9.00 \$

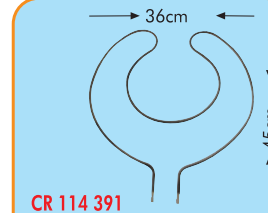

CR 114 391

Katmer Rezistansı
220V. 1000W. (6.5 Ø-Cr-ni)

9.50 \$

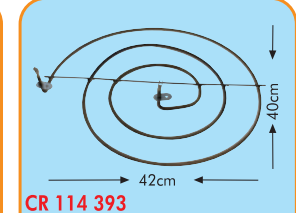

CR 114 393

Katmer Rezistansı
220V. 2000W. (6.5 Ø-Cr-ni)

8.50 \$

TOST BORU REZİSTANSLARI TOAST TUBE HEATERS

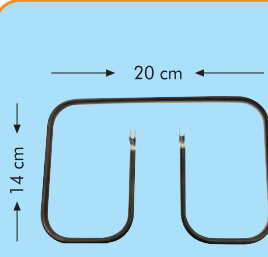

CR 115 101

Tost Boru Rezistansı (Arçelik)
110V. 800W (6.5 Ø-Cr-ni)

4.00 \$

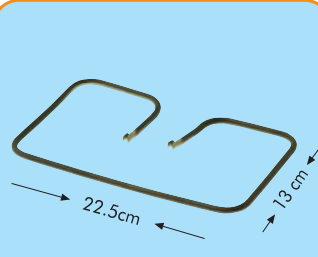

Tost Boru Rez. (Lider-Küçük)
800W (6.5 Ø-Cr-ni)

CR 115 103 110V
CR 115 104 220V

4.00 \$

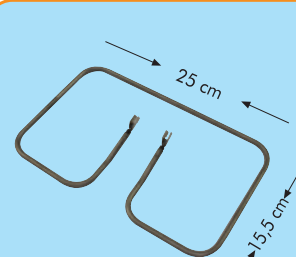

CR 115 111

Tost Boru Rez. (Lider-Büyük)
110V. 800W (6.5 Ø-Cr-ni)

4.00 \$

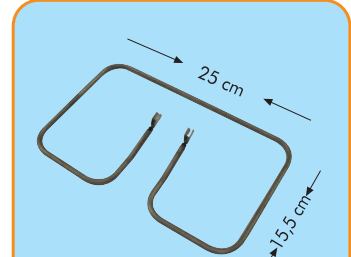

CR 115 112

Tost Boru Rez. (Lider-Büyük)
220V. 800W (6.5 Ø-Cr-ni)

4.00 \$

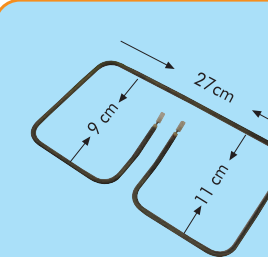

CR 115 115

Tost Boru Rez. (Lider-Büyük)
110V. 900W (6.5 Ø-Cr-ni)

4.00 \$

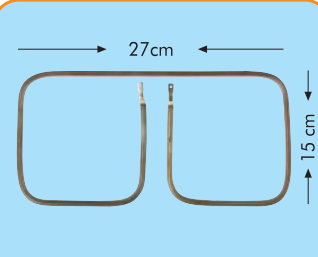

Büfeci Tost Rezistansı CR 115 121
110V. 750W (6.5 Ø-Cr-ni)

4.00 \$

Büfeci Tost Rezistansı CR 115 122
220V. 750W (6.5 Ø-Cr-ni)

4.00 \$

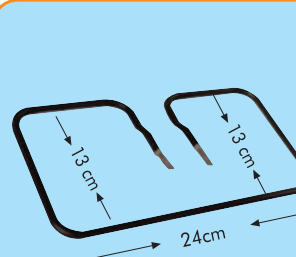

Tefal Tost Rezistansı CR 115 124
110V. 800W (6.5 Ø-Cr-ni)

4.00 \$

Tefal Tost Rezistansı CR 115 125
220V. 800W (6.5 Ø-Cr-ni)

4.00 \$

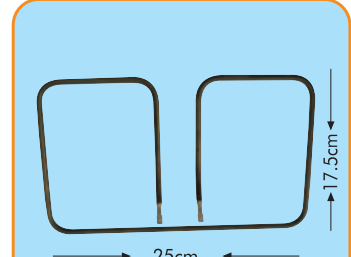

CR 115 126

Tefal Tost Rezistansı
220V. 1000W (6.5 Ø-Cr-ni)

4.00 \$

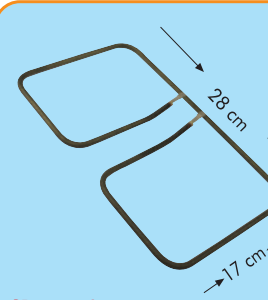

CR 115 127

Korkmaz Tost Rezistansı
110V. 1000W (6.5 Ø-Cr-ni)

4.00 \$

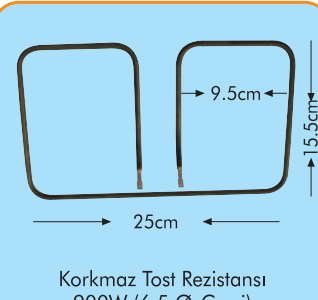

Korkmaz Tost Rezistansı
900W (6.5 Ø-Cr-ni)

CR 115 128 110V
CR 115 129 220V

4.00 \$

4.00 \$

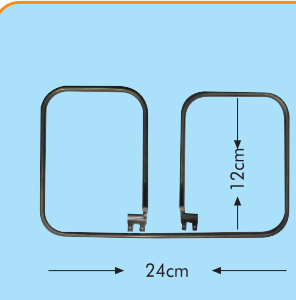

CR 115 130

Era Tost Rezistansı
110V. 800W (6.5 Ø-Cr-ni)

4.00 \$

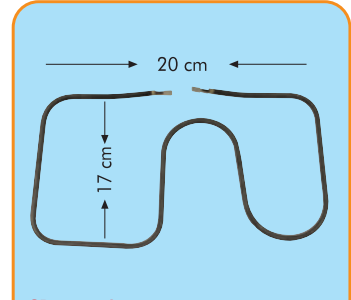

CR 115 131

Tost Rezistansı
110V. 800W (6.5 Ø-Cr-ni)

4.00 \$

TOST BORU REZİSTANSLARI

TOAST TUBE HEATERS

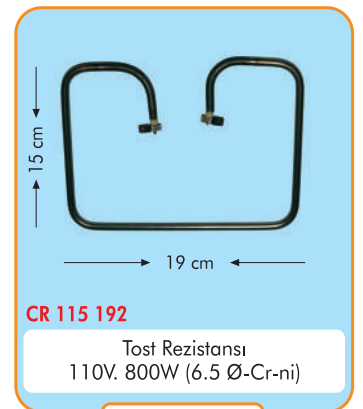
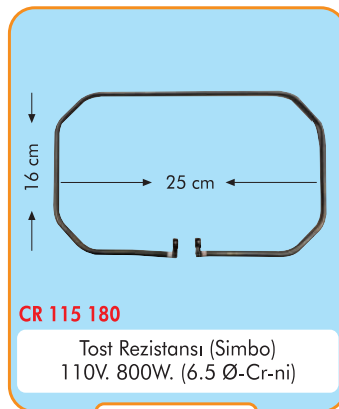
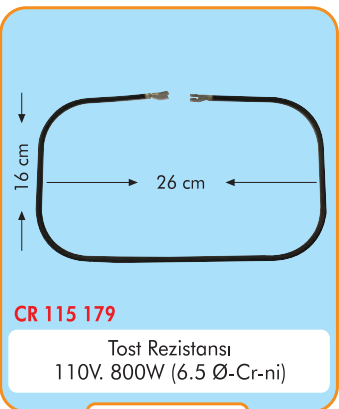
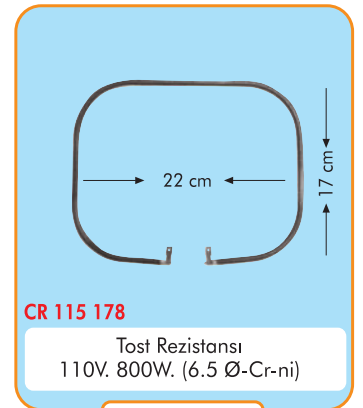
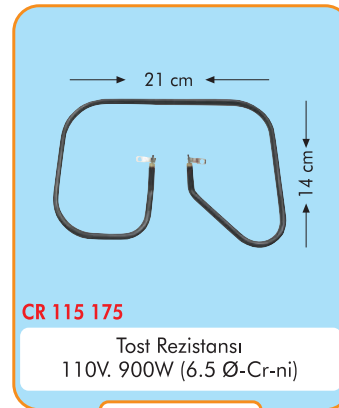
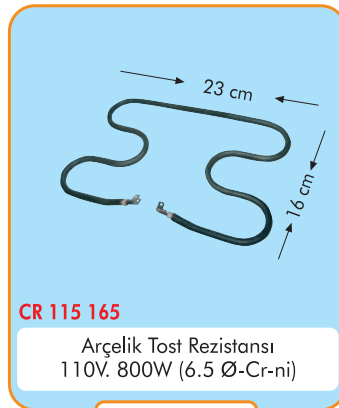
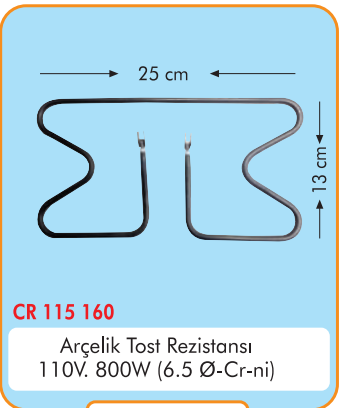
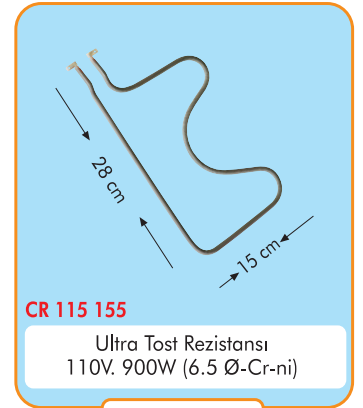
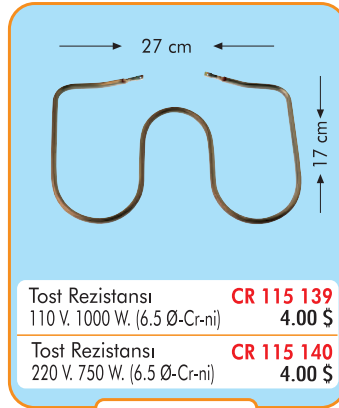
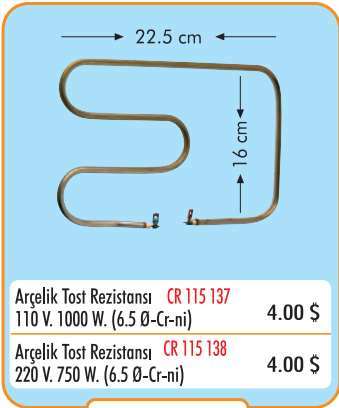
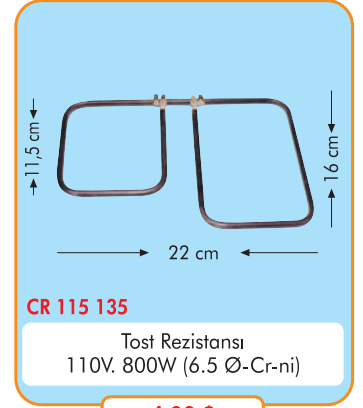
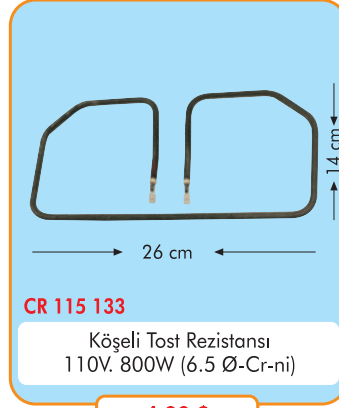
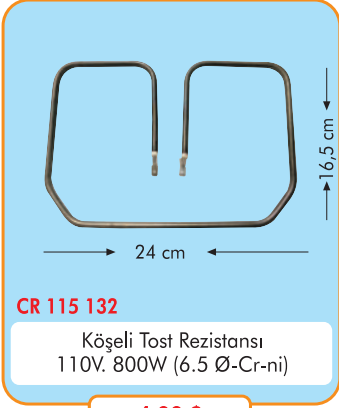

TOST BORU REZİSTANSLARI

TOAST TUBE HEATERS

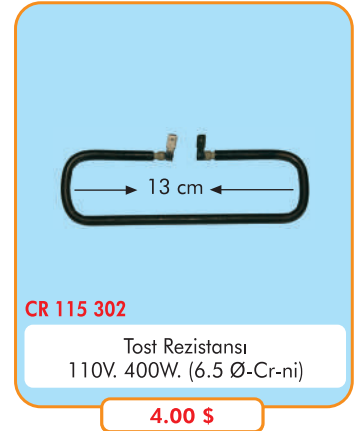
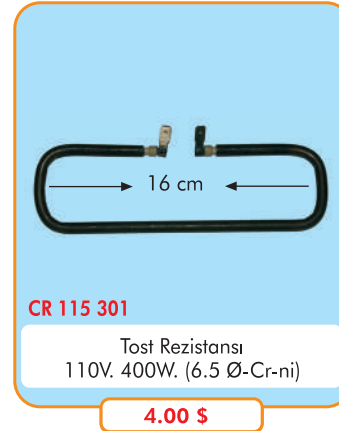
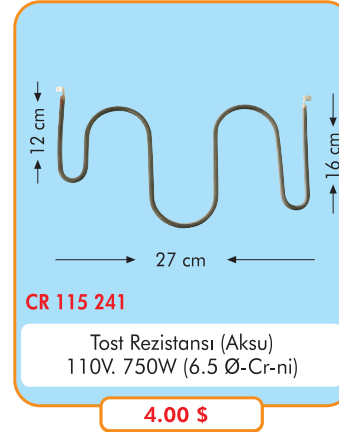
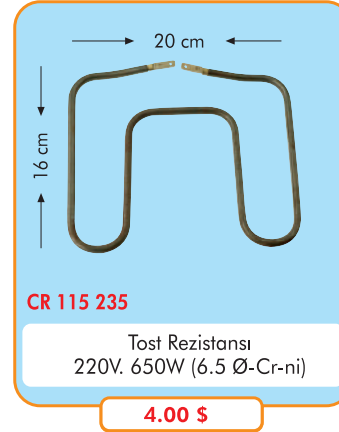
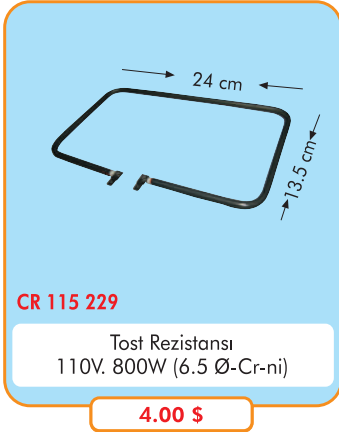
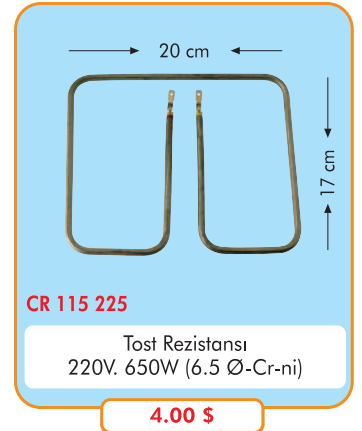
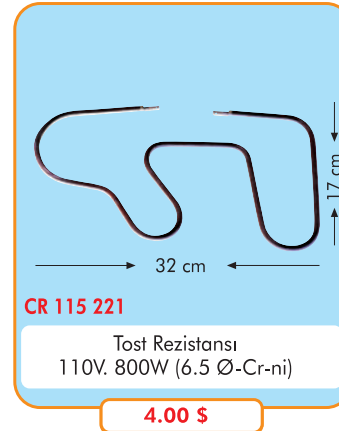
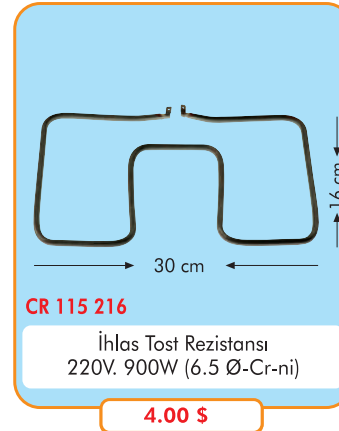
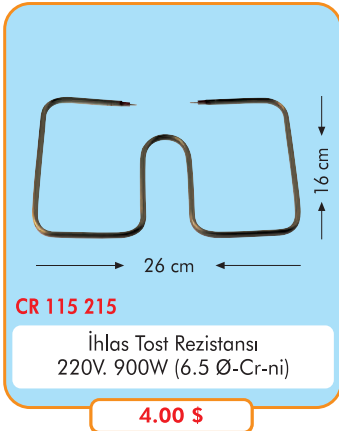
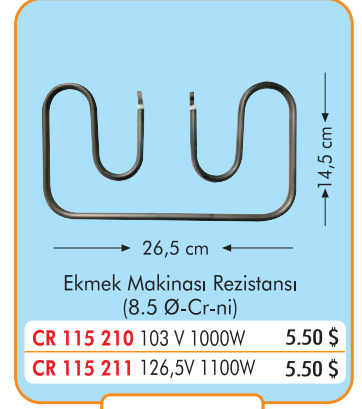
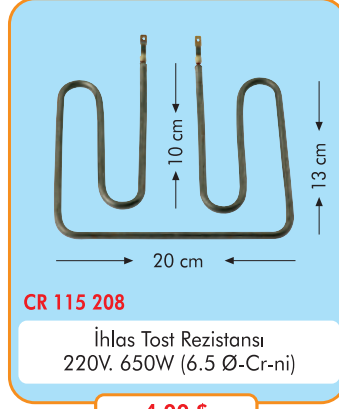
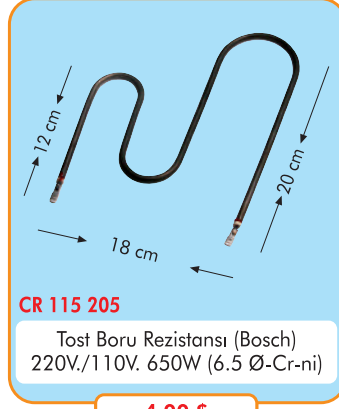
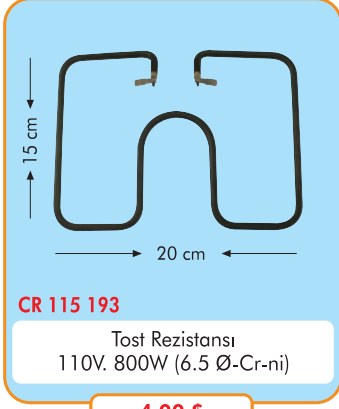

TOST BORU REZİSTANSLARI

TOAST TUBE HEATERS

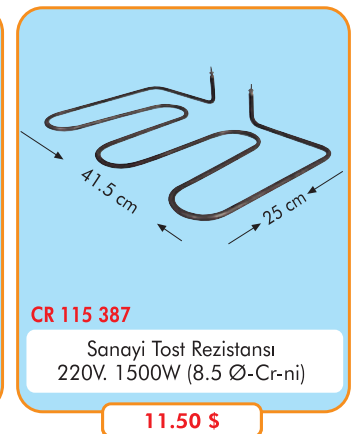
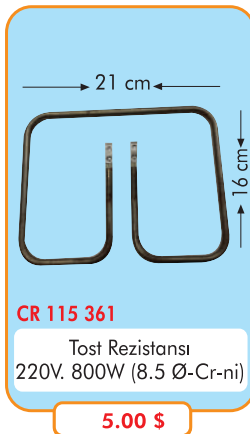
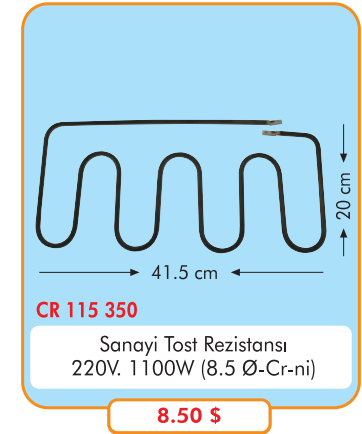
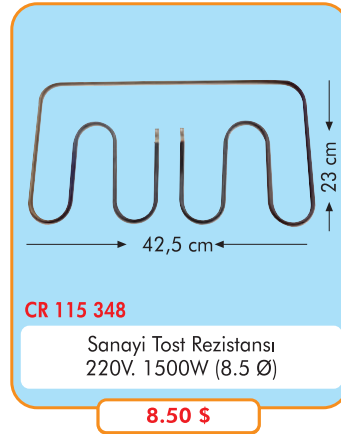
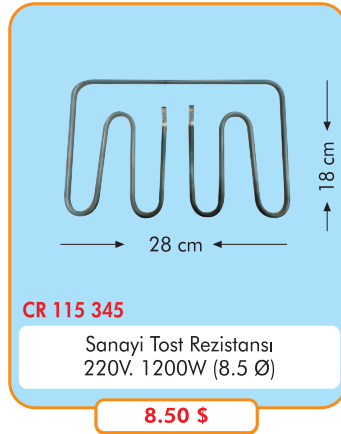
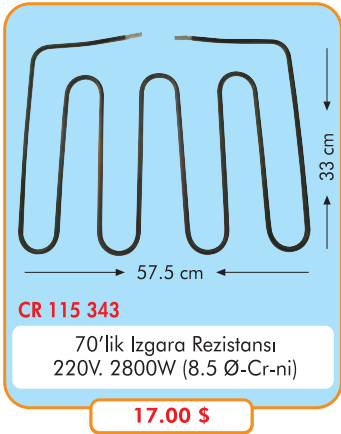
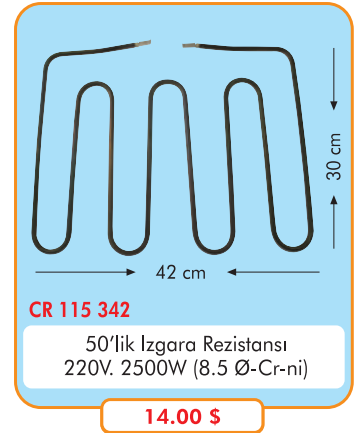
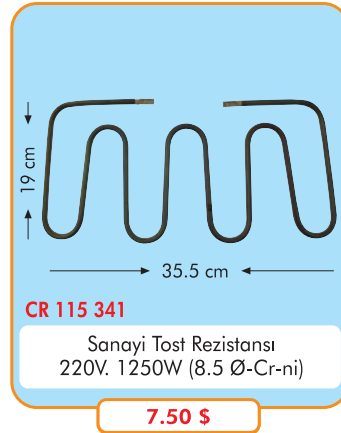
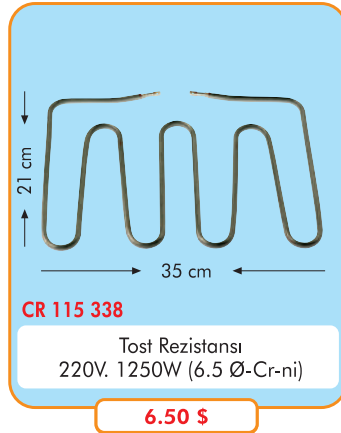
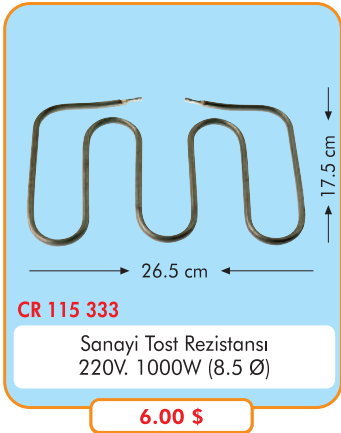
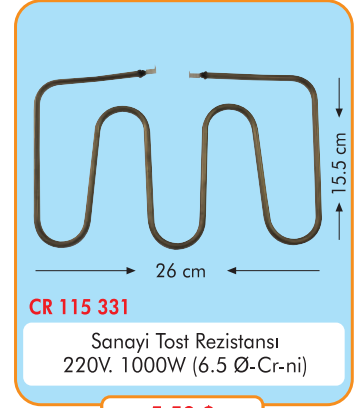
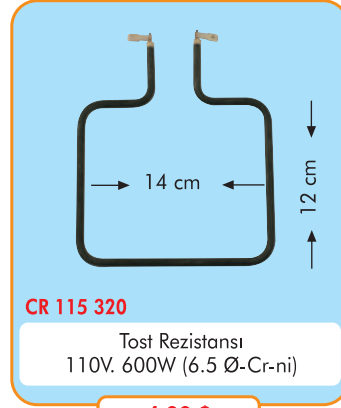

TOST BORU REZİSTANSLARI

TOAST TUBE HEATERS

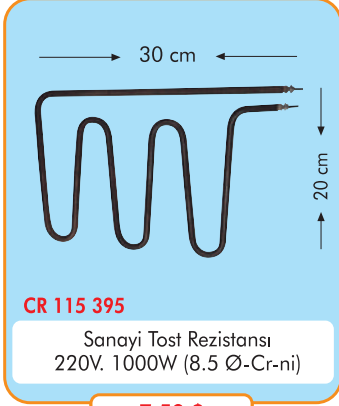

CR 115 395

Sanayi Tost Rezistansı
220V. 1000W (8.5 Ø-Cr-ni)

7.50 \$

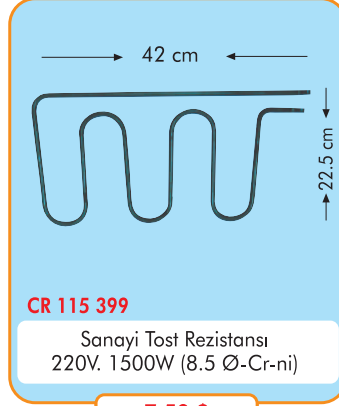

CR 115 399

Sanayi Tost Rezistansı
220V. 1500W (8.5 Ø-Cr-ni)

7.50 \$

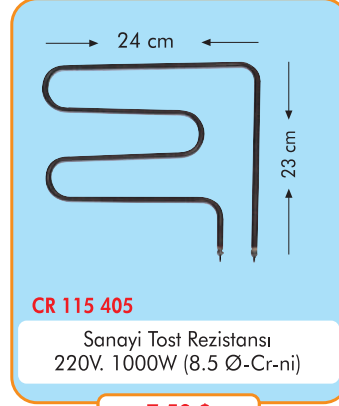

CR 115 405

Sanayi Tost Rezistansı
220V. 1000W (8.5 Ø-Cr-ni)

7.50 \$

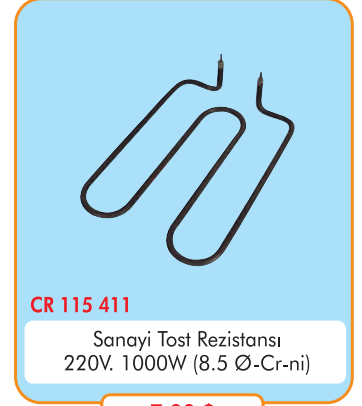

CR 115 411

Sanayi Tost Rezistansı
220V. 1000W (8.5 Ø-Cr-ni)

7.00 \$

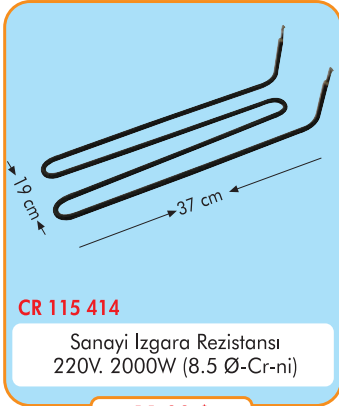

CR 115 414

Sanayi Izgara Rezistansı
220V. 2000W (8.5 Ø-Cr-ni)

11.00 \$



CR 115 415

Sanayi Izgara Rezistansı
220V. 2250W (8.5 Ø-Cr-ni)

11.00 \$



CR 115 417

Sanayi Izgara Rezistansı
220V. 2500W (8.5 Ø-Cr-ni)

14.00 \$

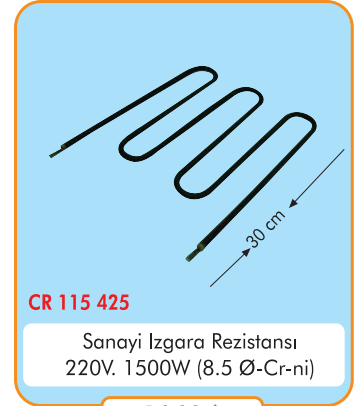

CR 115 425

Sanayi Izgara Rezistansı
220V. 1500W (8.5 Ø-Cr-ni)

14.00 \$

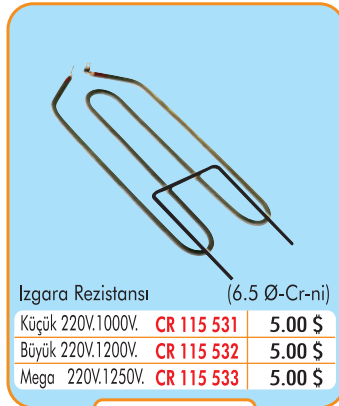

Izgara Rezistansı (6.5 Ø-Cr-ni)
Küçük 220V.1000V. CR 115 531 5.00 \$
Büyük 220V.1200V. CR 115 532 5.00 \$
Mega 220V.1250V. CR 115 533 5.00 \$

5.00 \$

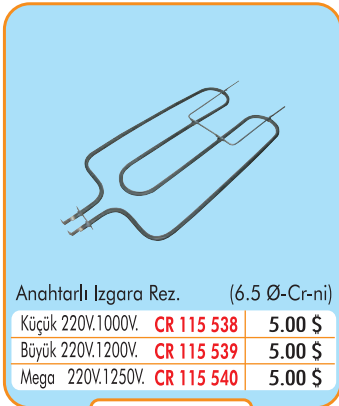

Anahtarlı Izgara Rez. (6.5 Ø-Cr-ni)
Küçük 220V.1000V. CR 115 538 5.00 \$
Büyük 220V.1200V. CR 115 539 5.00 \$
Mega 220V.1250V. CR 115 540 5.00 \$

5.00 \$



CR 115 599

Flanşsız Barbekü Rezistansı
220V. 2000W (6.5 Ø-Cr-ni)

4.50 \$

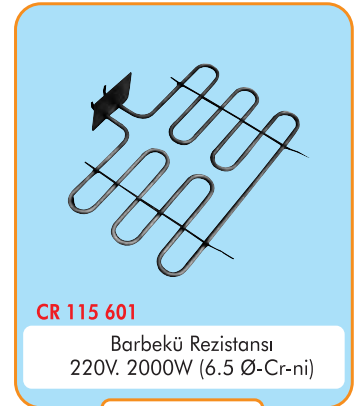

CR 115 601

Barbekü Rezistansı
220V. 2000W (6.5 Ø-Cr-ni)

6.00 \$



CR 115 602

Barbekü Rezistansı
230V. 2000W (6.5 Ø-Cr-ni)

6.00 \$

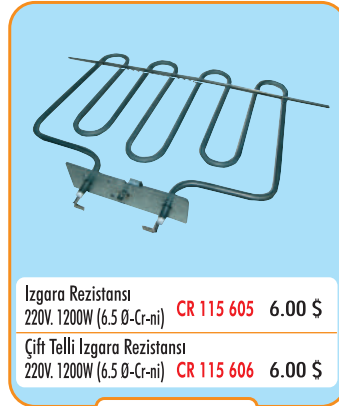

Izgara Rezistansı
220V. 1200W (6.5 Ø-Cr-ni) CR 115 605 6.00 \$
Çift Telli Izgara Rezistansı
220V. 1200W (6.5 Ø-Cr-ni) CR 115 606 6.00 \$

6.00 \$



CR 115 625

Balıkçı Izgara Rezistansı
220V. 1200W (6.5 Ø-Cr-ni)

6.00 \$

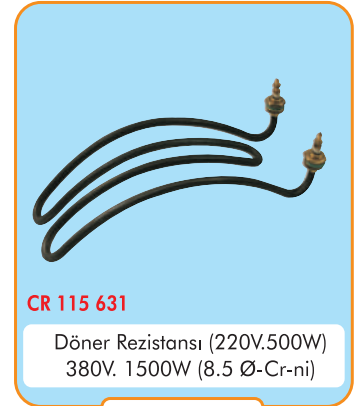

CR 115 631

Döner Rezistansı (220V.500W)
380V. 1500W (8.5 Ø-Cr-ni)

11.50 \$

FRİTÖZ REZİSTANSLARI

DEEP FRYER RESISTANCES

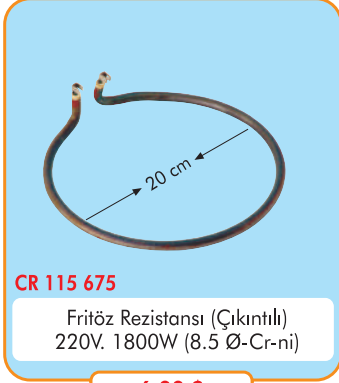

CR 115 675

Fritöz Rezistansı (Çıkıntılı)
220V. 1800W (8.5 Ø-Cr-ni)

6.00 \$

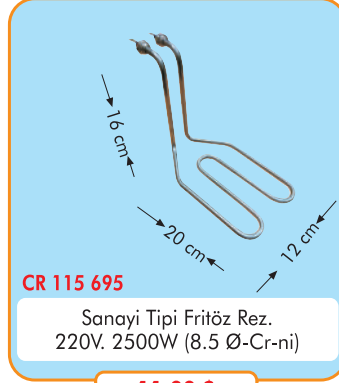

CR 115 695

Sanayi Tipi Fritöz Rez.
220V. 2500W (8.5 Ø-Cr-ni)

11.00 \$

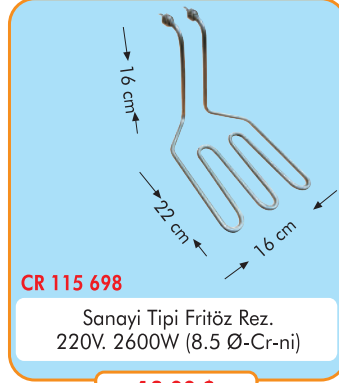

CR 115 698

Sanayi Tipi Fritöz Rez.
220V. 2600W (8.5 Ø-Cr-ni)

13.00 \$

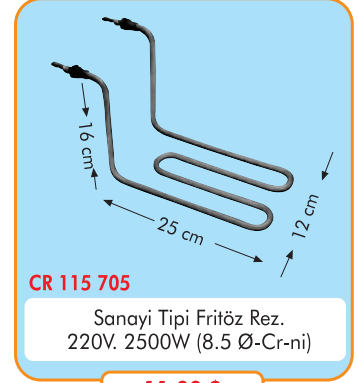

CR 115 705

Sanayi Tipi Fritöz Rez.
220V. 2500W (8.5 Ø-Cr-ni)

11.00 \$

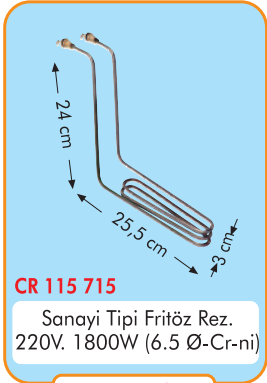

CR 115 715

Sanayi Tipi Fritöz Rez.
220V. 1800W (6.5 Ø-Cr-ni)

12.50 \$



CR 115 716

Fritöz Rezistansı
230V. 6000W (8.5 Ø-Cr-ni)

60.00 \$



CR 115 717

Fritöz Rezistansı
230V. 3500W (8.5 Ø-Cr-ni)

40.00 \$



CR 115 718

Fritöz Rezistansı
230V. 5500W (8.5 Ø-Cr-ni)

60.00 \$



CR 115 720

Sanayi Tipi Fritöz Rezistansı
380V. 3x2500W (8.5 Ø-Cr-ni)

125.00 \$

ENDÜSTRİYEL BORU REZİSTANSLARI

INDUSTRIAL TUBE HEATERS

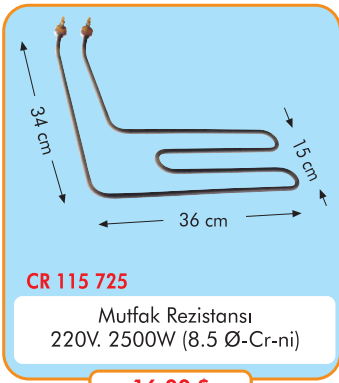

CR 115 725

Mutfak Rezistansı
220V. 2500W (8.5 Ø-Cr-ni)

16.00 \$

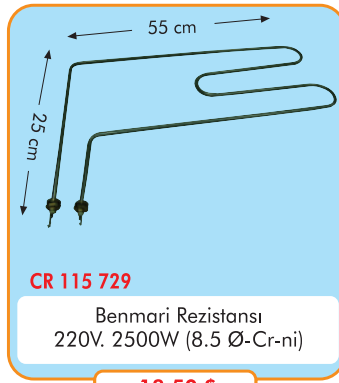

CR 115 729

Benmari Rezistansı
220V. 2500W (8.5 Ø-Cr-ni)

18.50 \$

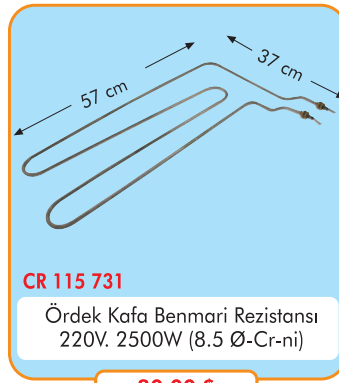

CR 115 731

Ördek Kafa Benmari Rezistansı
220V. 2500W (8.5 Ø-Cr-ni)

20.00 \$

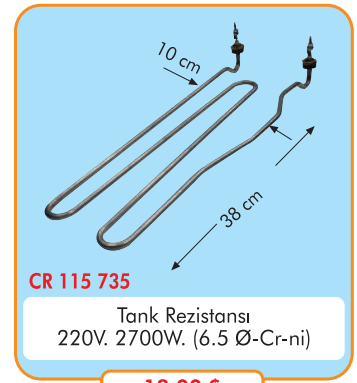

CR 115 735

Tank Rezistansı
220V. 2700W. (6.5 Ø-Cr-ni)

13.00 \$

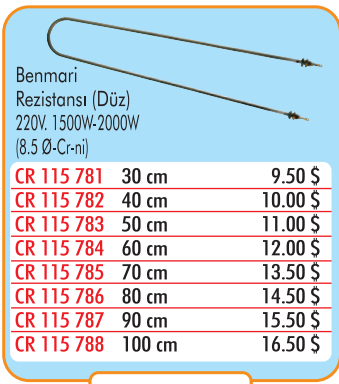

Benmari
Rezistansı (Düz)
220V. 1500W-2000W
(8.5 Ø-Cr-ni)

CR 115 781	30 cm	9.50 \$
CR 115 782	40 cm	10.00 \$
CR 115 783	50 cm	11.00 \$
CR 115 784	60 cm	12.00 \$
CR 115 785	70 cm	13.50 \$
CR 115 786	80 cm	14.50 \$
CR 115 787	90 cm	15.50 \$
CR 115 788	100 cm	16.50 \$

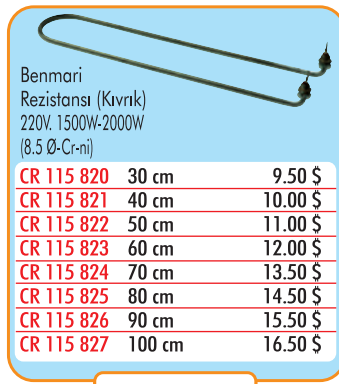

Benmari
Rezistansı (Kıvrık)
220V. 1500W-2000W
(8.5 Ø-Cr-ni)

CR 115 820	30 cm	9.50 \$
CR 115 821	40 cm	10.00 \$
CR 115 822	50 cm	11.00 \$
CR 115 823	60 cm	12.00 \$
CR 115 824	70 cm	13.50 \$
CR 115 825	80 cm	14.50 \$
CR 115 826	90 cm	15.50 \$
CR 115 827	100 cm	16.50 \$

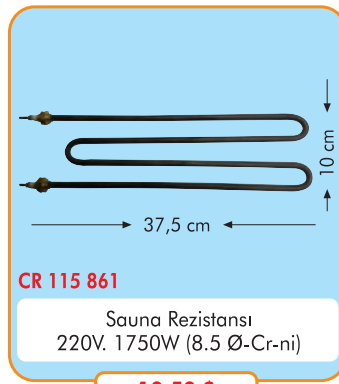

CR 115 861

Sauna Rezistansı
220V. 1750W (8.5 Ø-Cr-ni)

10.50 \$

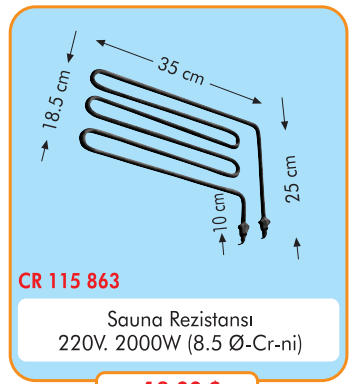

CR 115 863

Sauna Rezistansı
220V. 2000W (8.5 Ø-Cr-ni)

13.00 \$

ENDÜSTRİYEL BORU REZİSTANSLARI

INDUSTRIAL TUBE HEATERS

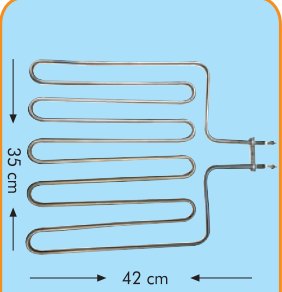

CR 115 864

Sauna Rezistansı
220V. 2500W (8.5 Ø-Cr-ni)

20.00 \$

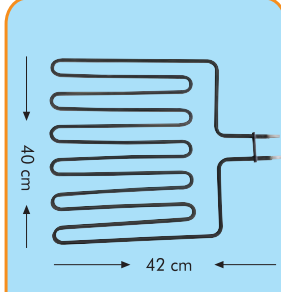

CR 115 865

Sauna Rezistansı
220V. 2500W (8.5 Ø-Cr-ni)

20.00 \$

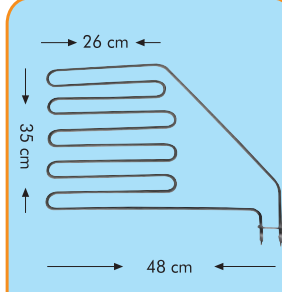

CR 115 869

Sauna Rezistansı
220V. 2500W (8.5 Ø-Cr-ni)

20.00 \$



Endüstriyel Bul. Mak. Rez. (1)
220V. 4500-6000-7500-9000-10000W
(8.5 Ø-Cr-ni) **CR 116 101 23.00 \$**

Büyük Kafalı Endüstriyel Bul.
Makinası Rez. (2)
220V. 6000-7500-9000-10000W
(8.5 Ø-Cr-ni) **CR 116 115 30.00 \$**



CR 116 117

Üçgen Flanş Tank Rezistansı
220V. 3000W (6.5 Ø-Cr-ni)

18.00 \$



CR 116 119

Eğik Kafa Büyük Üçgen Flanşlı Rez.
220V. 380W 3x1500W (8.5 Ø-Cr-ni)

25.00 \$



Mini Üçgen Flanş Bulaşık Makinası Rez.
230V. 3000W (6.5 Ø-Cr-ni)

CR 116 122 16.00 \$

230V. 2000W (6.5 Ø-Cr-ni)

CR 116 124 14.00 \$

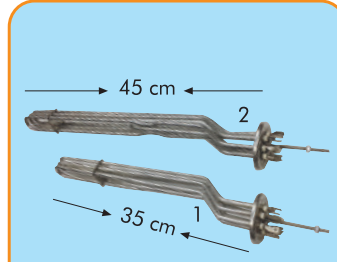

CR 116 131

Yuvarlak Flanşlı BYM Rezistansı
380/220V. 3x3000W (6.5 Ø-Cr-ni)
(Kısa (1) - Uzun (2))

43.00 \$

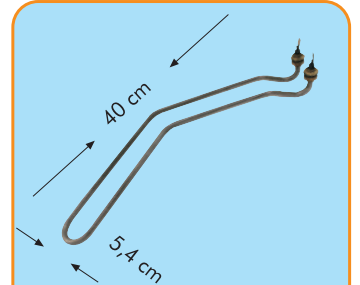

CR 116 135

Bym Tank Rezistansı
230V. 2500W (8.5 Ø-Cr-ni)

12.00 \$

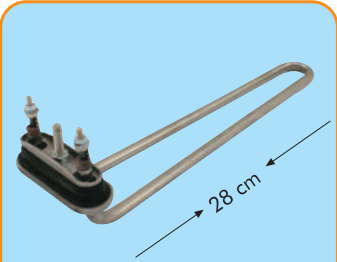

CR 116 137

Bardak Yıkama Rezistansı
220V. 1000W (8.5 Ø-Cr-ni)

20.00 \$

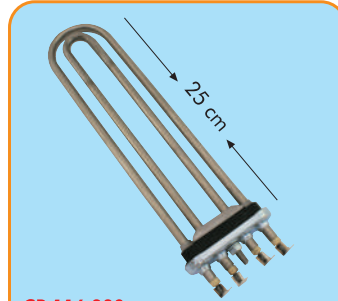

CR 116 239

Çamaşır Makina Rezistansı
220V. 2x2000W (8.5 Ø-Cr-ni)

14.00 \$

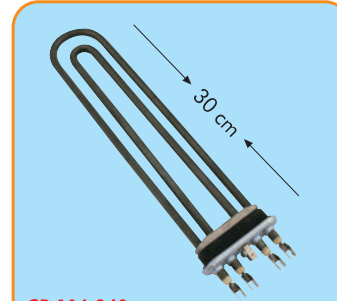

CR 116 240

Çamaşır Makina Rezistansı
220V. 2x2650W (8.5 Ø-Cr-ni)

14.00 \$



CR 116 241

Öztiyıklar Çamaşır Makinası Rez.
220V. 2 x 2500W (8.5-Ø-Cr-ni)

14.00 \$

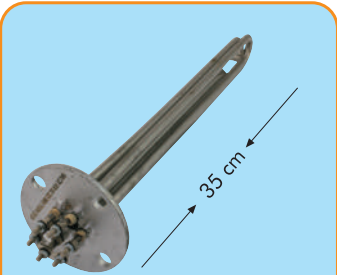

CR 116 242

Endüstriyel Bulaşık Makinası Rez.
220V. 6000W (8.5 Ø-Cr-ni)

27.00 \$

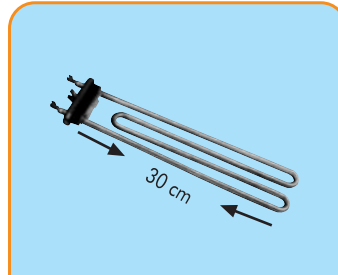

AEG/ARÇELİK Çam. Mk. Rez.
220V. 2000W (8.5 Ø-Cr-ni) **CR 116 245 7.00 \$**

TOLKAR Çam. Mak. Rez.
220V. 3000W (8.5 Ø-Cr-ni) **CR 116 248 7.00 \$**

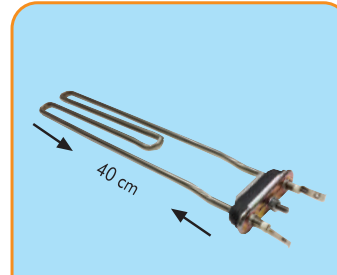

CR 116 251

OÇM Endüstriyel Rezistansı (Eğri)
220V. 4000W (8.5 Ø-Cr-ni)

13.50 \$

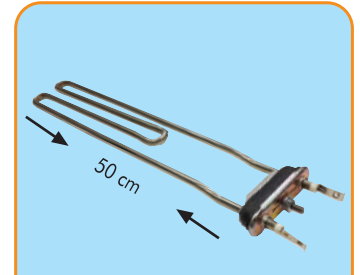

CR 116 252

OÇM Endüstriyel Rezistansı (Eğri)
220V. 5000W (8.5 Ø-Cr-ni)

14.50 \$

ENDÜSTRİYEL BORU REZİSTANSLARI INDUSTRIAL TUBE HEATERS

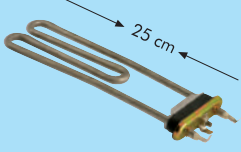

CR 116 253

BOSCH Çamaşır Mak. Rez.
220V. 2000W (8.5 Ø-Cr-ni)

7.00 \$

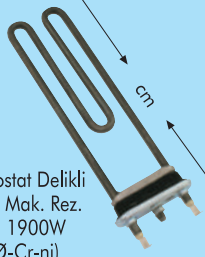

Termostat Delikli
Çam. Mak. Rez.
220V. 1900W
(8.5 Ø-Cr-ni)

CR 116 255 17 cm. **7.00 \$**

CR 116 256 22 cm. **7.00 \$**

CR 116 257 24 cm. **7.00 \$**

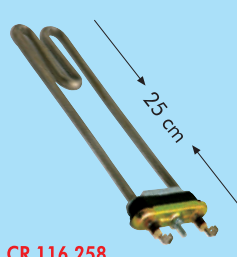

CR 116 258

AEG Çamaşır
Makinası Rez.
220V. 2000W
(8.5 Ø-Cr-ni)

7.00 \$

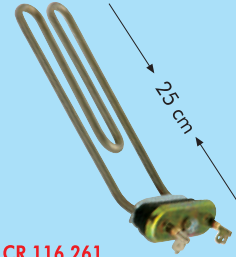

CR 116 261

VESTEL Çamaşır Mak.
Rezistansı
220V. 2000W
(8.5-Ø-Cr-ni)

7.00 \$

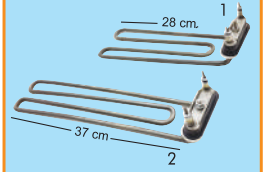

Çamaşır Makinası Rezistansı
220V. 2800W (8.5-Ø-Cr-ni)

Kısa (1) **CR 116 265** **11.50 \$**

Uzun (2) **CR 116 266** **12.50 \$**

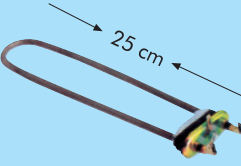

CR 116 275

SİMTEL Çamaşır Mak. Rez.
220V. 2000W (8.5-Ø-Cr-ni)

7.00 \$

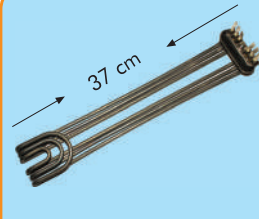

FAGOR Kazan Rezistansı
220V. 4500W (6.5-Ø-Cr-ni)

CR 116 375 **68.00 \$**

CR 116 376 (BALÇIK) **22.00 \$**

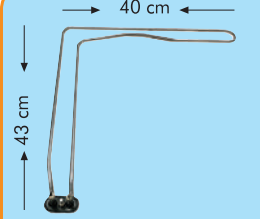

CR 116 387

Bulaşık Makinası Rezistansı
220V. 2000W (8.5-Ø-Cr-ni)

22.00 \$

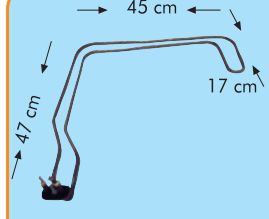

CR 116 391

Bulaşık Makinası Rezistansı
220V. 2000W (8.5-Ø-Cr-ni)

25.00 \$

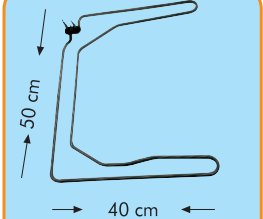

CR 116 395

Bulaşık Makinası Rezistansı
220V. 2000W (8.5-Ø-Cr-ni)

26.00 \$

SU ve YAĞ (KAFALI) ISITICILARI WATER AND OIL HEATERS

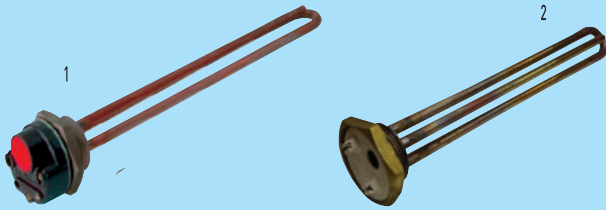

ÇİN MALI TERMOVAT ISITICILAR

CR 117 101 1-1/4 ÇİN DÜZ 30 cm. BAKIR 2000W. - 220V. TERMİKLİ (1) **12.00 \$**

CR 117 105 1-1/4 ÇİN DÜZ 30 cm. BAKIR 2000W. - 220V. TERMİKSİZ (2) **8.00 \$**



YERLİ MALI TERMOVAT ISITICILAR

CR 117 151 1-1/4 YERLİ DÜZ BAKIR 30 cm. 2000W. - 220V. TERMİKSİZ (1) **13.00 \$**

CR 117 181 1-1/4 YERLİ DÜZ BAKIR 40 cm. 2000W. - 220V. TERMİKSİZ (1) **14.50 \$**

CR 117 191 1-1/4 YERLİ DÜZ BAKIR 60 cm. 3000W. - 220V. TERMİKSİZ (1) **17.00 \$**

CR 117 211 1-1/4 YERLİ DÜZ BAKIR 90 cm. 2000W. - 220V. TERMİKSİZ (1) **21.00 \$**

CR 117 231 1-1/4 YERLİ KIVRIK BAKIR 30 cm. 2000W. - 220V. TERMİKSİZ (2) **15.00 \$**

CR 117 241 1-1/4 YERLİ KIVRIK BAKIR 30 cm. 3000W. - 220V. TERMİKSİZ (2) **16.00 \$**

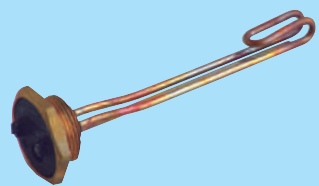

CR 117 251

İnce Dişli Yerli Bakır 1-1/4" Kıvrık Rez.
220V. 2000W (8.5 Ø-Cu-ni)

15.00 \$



CR 117 255

1 1/4" Yerli Kısa 20 cm. Rez. Bakır Kıvrık
220V. 2000W (8.5 Ø-Cu)

15.00 \$

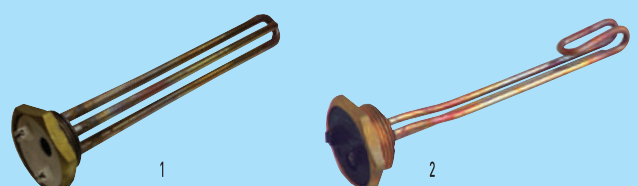

İTALYAN MALI TERMOVAT ISITICILAR

CR 117 271 1-1/4 İTALYAN DÜZ BAKIR 30 cm. 2000W. - 220V. TERMİKSİZ (1) **16.00 \$**

CR 117 281 1-1/4 İTALYAN DÜZ BAKIR 40 cm. 2000W. - 220V. TERMİKSİZ (1) **18.00 \$**

CR 117 291 1-1/4 İTALYAN KIVRIK BAKIR 30 cm. 2000W. - 220V. TERMİKSİZ (2) **19.00 \$**

SU ve YAĞ (KAFALI) ISITICILARI

WATER AND OIL HEATERS



KROM Termovat Isıtıcılar (Termiksiz)

CİNSİ	BOY	WATT	VOLT	KOD	FİYAT
1-1/4 Düz	30cm	2000W	220V	CR 117 301	12.00 \$
1-1/4 Düz	40 cm	3000W	220V	CR 117 306	13.50 \$
1-1/4 Düz	60 cm	3000W	220V	CR 117 311	15.00 \$
1-1/4 Düz	90 cm	3000W	220V	CR 117 321	18.00 \$

8.5 Ø-Cr-ni (Krom)



CR 117 331

1 1/4 Kıvrık Termovat Isıtıcı (Termiksiz)
220V. 2000W 8.5 Ø-Cr-ni (Krom)

13.50 \$

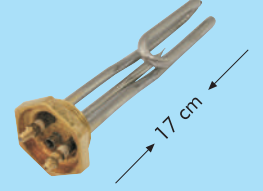

CR 117 341

Kuyumcu Mak. Rez.
220V. 1-1/4" 1750W 8.5 Ø-Cr-ni

13.00 \$



CR 117 351

Meşale Rezistansı 1-1/4 Düz
220V. 2000W 8.5 Ø-Cr-ni

15.00 \$



CR 117 352

Meşale Rezistansı 1-1/4 Düz
220V. 3000W 8.5 Ø-Cr-ni

15.00 \$

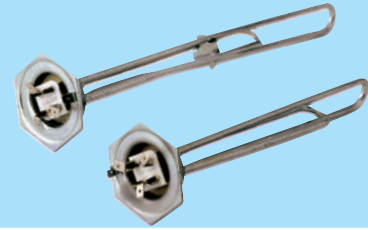

Yağlı Radyatör Rezistansı

KOD	CİNSİ	BOY	WATT	VOLT	FİYAT
CR 117 371	1-1/4	20cm	2000W	220V	10.00 \$
CR 117 373	1-1/4	32cm	2500W	220V	11.00 \$

6.5 Ø-Cr-ni (Krom) Çift Elemanlı



1.5'' inc

Kafalı Isıtıcılar

CİNSİ	BOY	WATT	VOLT	KOD	FİYAT
1-1/2	30cm	3000W	220V-380V	CR 117 401	23.00 \$
1-1/2	30cm	4500W	220V-380V	CR 117 403	23.00 \$
1-1/2	35cm	6000W	220V-380V	CR 117 405	23.00 \$
1-1/2	35cm	7500W	220V-380V	CR 117 407	24.00 \$
1-1/2	40cm	10000W	220V-380V	CR 117 409	24.50 \$
1-1/2	45cm	12000W	220V-380V	CR 117 412	28.00 \$
1-1/2	50cm	15000W	220V-380V	CR 117 414	29.00 \$

8.5 Ø-Cr-ni (Krom)



2'' inc

Kafalı Isıtıcılar

CİNSİ	BOY	WATT	VOLT	KOD	FİYAT
2''inc	30cm	3000W	220V-380V	CR 117 501	25.00 \$
2''inc	30cm	4500W	220V-380V	CR 117 503	25.50 \$
2''inc	35cm	6000W	220V-380V	CR 117 505	25.50 \$
2''inc	35cm	7500W	220V-380V	CR 117 507	27.00 \$
2''inc	40cm	10000W	220V-380V	CR 117 509	28.50 \$
2''inc	45cm	12000W	220V-380V	CR 117 512	29.50 \$
2''inc	50cm	15000W	220V-380V	CR 117 514	31.50 \$

8.5 Ø-Cr-ni (Krom)

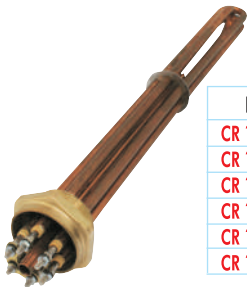

1.5'' inc

Kafalı Isıtıcılar BAKIR

KOD	CİNSİ	BOY	WATT	VOLT	FİYAT
CR 117 520	1-1/2	30cm	4500W	220V-380V	32.00 \$
CR 117 521	1-1/2	35cm	6000W	220V-380V	32.00 \$
CR 117 522	1-1/2	35cm	7500W	220V-380V	32.00 \$
CR 117 523	1-1/2	40cm	10000W	220V-380V	35.00 \$
CR 117 524	1-1/2	45cm	12000W	220V-380V	40.00 \$
CR 117 525	1-1/2	50cm	15000W	220V-380V	42.50 \$

8.5 Ø-Cu



2'' inc

Kafalı Isıtıcılar BAKIR

KOD	CİNSİ	BOY	WATT	VOLT	FİYAT
CR 117 530	2''	30cm	4500W	220V-380V	33.00 \$
CR 117 531	2''	35cm	6000W	220V-380V	34.50 \$
CR 117 532	2''	35cm	7500W	220V-380V	35.50 \$
CR 117 533	2''	40cm	10000W	220V-380V	37.50 \$
CR 117 534	2''	45cm	12000W	220V-380V	42.50 \$
CR 117 535	2''	50cm	15000W	220V-380V	45.00 \$

8.5 Ø-Cu

SU ve YAĞ (KAFALI) ISITICILARI

WATER AND OIL HEATERS



Pot Isıtıcılar

KOD	CİNSİ	BOY	WATT	VOLT	FİYAT
CR 117 551	1-1/2	26cm	2000W	230V	15.00 \$
CR 117 553	1-1/2	26cm	2500W	230V	15.00 \$
CR 117 555	1-1/2	26cm	3000W	230V	16.00 \$

8.5 Ø-Cr-ni (Krom)



Malkan Isıtıcı

KOD	CİNSİ	BOY	WATT	VOLT	FİYAT
CR 117 565	1-1/2	25cm	4000W	220V	20.00 \$

8.5 Ø-Cr-ni (Krom) Çift Elemanlı

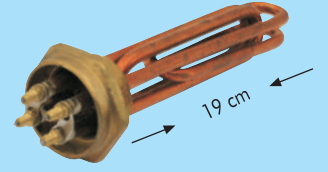

CR 117 567

Bakır Malkan Isıtıcı 1-1/2 Düz (Çift Elemanlı)
220V. 4500W 8.5 Ø-Cu

25.50 \$

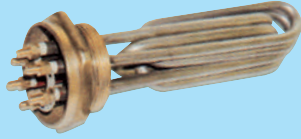

Tolon Isıtıcı

KOD	CİNSİ	BOY	WATT	VOLT	FİYAT
CR 117 571	2"inc	26 cm	6000 W.	220/380V.	28.50 \$
CR 117 575	2"inc	26 cm	7500 W.	220/380V.	28.50 \$
CR 117 578	2"inc	26 cm	10000 W.	220/380V.	28.50 \$

8.5 Ø-Cr-ni (Krom)

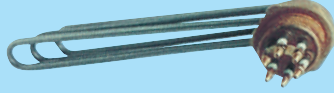

CR 117 595

Endüstriyel Çamaşır Makinası
Rezistansı 220V. 5500W
(2" inc) (8,5 Ø Cr-ni)

28.50 \$

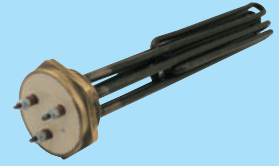

CR 117 605

2" Somunlu İlaç Dolgulu Kazan Rezistansı
230V.-380V 10000W 8.5 Ø-Cr-ni

40.00 \$

SERPANTİNLİ REZİSTANSLAR CONVERTOR HEATERS



Paskala Konfeksiyon Ütü Rez.
220 V. 800 W. (6.5 Ø-Cr-ni) CR 117 701 6.50 \$

Paskala Konfeksiyon Ütü Rez.
220 V. 800 W. (8.5 Ø-Cr-ni) CR 117 702 9.00 \$



CR 117 745

U Tipi Serpantinli Rezistanslar
25 cm.=500W.-40cm=800W-50cm=1000W 220 V.
75cm=1500W - 100cm=2000W. 220 V.
(8.5 - 11.5 Ø-Cr-ni)

SORUNUZ



CR 117 765

M Tipi Serpantinli Rezistanslar
25 cm.=500W.-30cm=1000W 220 V.
50cm=1200W - 65 cm=2000W 220 V.
(8.5 - 11.5 Ø-Cr-ni)

SORUNUZ



CR 117 785

Düz Serpanti Rezistanslar
40 cm.=500W.-50cm=500W 220 V.
75 cm=800W - 100 cm=1000W 220 V.
150 cm=2000W (8.5 - 11.5 Ø-Cr-ni)

SORUNUZ

ÜTÜ REZİSTANSLARI IRON HEATERS



CR 118 101

Mika Ütü Rezistansı
(220V.450W.) 1 Paket 10Ad.

3.75 \$



CR 118 105

Blendajlı (Sac) Ütü Rezistansı
(220V.450W.) 1 Paket 10Ad.

5.00 \$



CR 118 112

Kaliteli Terzi Ütü Rezistansı
(220V.750W.) 1 Paket 10 Ad.

6.00 \$



CR 118 121

Otomatik Ütü Rezistansı
(220V.600W.) 1 Paket: 10 Ad.

5.00 \$



CR 118 152

Şilte Tipi Alüminyum Döküm
Ütü Rezistansı (220V. 800W)

14.00 \$



CR 118 165

Plastik Kaynak
Makina Rezistansı (İkili)

11.50 \$

ISITICILAR HEATERS



CR 118 201
Orion Seramik Rezistans
500-650-750-1000W (220V)
(Farklı Ölçüleri Sorunuz.)

20.00 \$



CR 118 251
Kaset Rezistansı (1) 7.00 \$
CR 118 281
Soba Buhar Rezistansı (2) 1.75 \$



CR 118 301
Kesilebilir Kablo Tipi Rezistans
1 mt.=50 W. 220 V (Tek parçada
en fazla 50 mt. kullanılır)

3.60 \$



Drenaj Rezistansı

CR 118 305	1 mt. 230 V -50W	5.00 \$
CR 118 306	2 mt. 230 V -100W	8.50 \$
CR 118 307	3 mt. 230 V -150W	12.00 \$
CR 118 308	4 mt. 230 V -200W	15.30 \$
CR 118 309	5 mt. 230 V -250W	19.00 \$
CR 118 310	6 mt. 230 V -300W	22.00 \$



CR 118 321
Halı Altı Film Isıtıcı
1 metre = 240 W - 220 V.
1 Top =100 metre

10.00 \$



5 M. ısı bandı (100 W.)
CR 118 338 8.00 \$
10 M. ısı bandı (175 W.)
CR 118 340 17.50 \$



CR 118 361
Battaniye Rezistans Teli (0.25 mm)
(1 Top:1000m.)
Çift Kişilik ölçü : 27 metredir.

0.12 \$



CR 118 371
Termostatlısız- Reşo Rezistans
220 V.(Alüminyum)
20x25cm. 750W

48.00 \$



Termostatlı- Reşo Rezistans
220 V. (Alüminyum)

CR 118 392	20x25cm. 750W
CR 118 395	20x20cm. 500W

68.50 \$



CR 118 401
Silikonlu Açık Büfe Rezistansı
(Yapışkanlı Emniyet Termostatlı)
20 x 25 cm. 500 W. 220 V.

57.00 \$



Silikonlu Benmarı Rezistansı
(Yapışkanlı Emniyet Termostatlı)

CR 118 411	30x40cm. 1200W	65.00 \$
CR 118 412	30x50cm. 1500W	73.00 \$



14.5 cm.
Ocak Pleyti
(Hot Plate)
(1000W. 220V)

CR119101	4'lü klemensli	13.00 \$
CR119103	2 soketli	13.00 \$
CR119105	4 soketli	13.00 \$



18 cm.
Ocak Pleyti
(Hot Plate)
(1500W. 220V)

CR119111	4'lü klemensli	16.00 \$
CR119113	2 soketli	16.00 \$
CR119115	4 soketli	16.00 \$



CR 119 119
9 cm. Ocak Pleyti (Hot Plate)
(350W. 220V)

11.00 \$



CR 119 121
22 cm. Ocak Pleyti (Hot Plate)
(2000W. 220V)

35.00 \$



CR 119 131
Rapidli Pleyt (14.5cm) 1500W (220V)

16.00 \$



CR 119 135
Rapidli Pleyt (18cm) 2000W

20.00 \$



CR 119 136
22 cm. Rapidli Pleyt
2600W 380-440 V

42.00 \$



CR 119 141
30x30 cm Kare Pleyt
(3000-3500-4000W) (220-380-440V)

170.00 \$



CR 119 151
40x40 cm Kare Pleyt
(3000-3500-4000W) (220-380-440V)

340.00 \$

ANAHTAR ÇEŞİTLERİ

MICRO SWITCHES



CR 201 099

Mini Mini Işksız Anahtar
(2 Bağlantılı)

0.30 \$



CR 201 101

Mini Işksız Anahtar
(2. Kalite) (2 Bağlantılı)

0.30 \$



CR 201 102

Mini Işksız Anahtar
(1. Kalite / Renk Değişkendir)
(2 Bağlantılı)

0.60 \$



CR 201 103

Mini Işksız 4 Bağlantılı
Anahtar

0.60 \$



CR 201 104

Mini Light Işksız
Anahtar (Yaylı)

0.45 \$



CR 201 105

1-0-2 Mini Işksız Anahtar
(3 Bağlantı)

0.45 \$



CR 201 151

Mini Işklı Anahtar
(Kırmızı-Yeşil-Sarı) 3 Bağlantılı

0.55 \$



CR 201 152

Mini Işklı Anahtar
(Kırmızı) 4 Bağlantılı

0.60 \$



CR 202 101

Orta Geniş 0-1
Işksız Anahtar

0.80 \$



CR 202 102

Orta Geniş 1-0-2
Işksız Anahtar

0.80 \$



CR 202 109

Orta Geniş Işklı
Anahtar

0.80 \$



CR 203 101

Tekli Işksız
Anahtar

0.45 \$



CR 203 102

Kaliteli Tekli Işksız
Anahtar 25A

0.60 \$



CR 203 105

Tekli Çift Renk
Işksız Anahtar

0.45 \$



CR 203 109

1-0-2 Tekli
Işksız Anahtar

0.95 \$



CR 203 110

Yaylı 1-0-2 Tekli
Işksız Anahtar

1.10 \$

ANAHTAR ÇEŞİTLERİ

MICRO SWITCHES



CR 203 112

0 - 1 - 2 Saç Kurutma Anahtarı

0.80 \$



CR 203 118

Arçelik Fırın Anahtarı (1-0-2) Siyah-Beyaz

3.00 \$



CR 203 121

Tekli Işıklı Anahtar 16A

0.55 \$



CR 203 122

Kaliteli Tekli Işıklı Anahtar 25A

0.85 \$



CR 203 123

Tekli Işıklı Yeşil Anahtar 16A

0.65 \$



CR 203 124

Tekli Işıklı Sarı Anahtar 16A

0.65 \$



CR 203 125

Tekli Led Işıklı Anahtar

0.80 \$



CR 204 101

Geniş Işıksız Anahtar 16A

0.70 \$



CR 204 102

Kaliteli Geniş Işıksız Anahtar 25A

1.00 \$



CR 204 105

Geniş Çift Renk Işıksız Anahtar 16A

0.75 \$



Geniş Işıksız (0-1) 6 Bağlantılı Anahtar

CR 204 106 Yaylı 1.10 \$
CR 204 107 1.00 \$



CR 204 108

Yaylı Geniş Işıksız 0-1 Anahtar

1.00 \$



CR 204 109

Geniş 1-0-2 Işıksız Anahtar (6 Bağlantılı)

1.50 \$



CR 204 110

Yaylı - Geniş 1-0-2 Işıksız Anahtar (6 Bağlantılı)

1.50 \$



CR 204 115

Körüklü Geniş Işıklı Anahtar Kırmızı 16A

1.75 \$



CR 204 116

Körüklü Geniş Işıklı Anahtar Sarı 16A

1.75 \$

ANAHTAR ÇEŞİTLERİ

MICRO SWITCHES



CR 204 117
Körüklü Geniş
Işıklı Anahtar Yeşil 16A

1.75 \$



CR 204 121
Geniş Işıklı - Difaze Anahtar
(4 Bağlantılı) 16A

0.75 \$



CR 204 122
Kaliteli Geniş Işıklı Difaze Anahtar
(4 Bağlantılı) 25A

1.35 \$



CR 204 124
Kaliteli Geniş Işıklı Difaze Anahtar
(5 Bağlantılı) 32A

1.40 \$



Geniş Işıklı Anahtar (4 Bağlantılı) 16A

CR 204 203 Sarı
CR 204 204 Yeşil

0.75 \$



CR 204 205
Geniş Işıklı Anahtar (4 Bağlantılı) 16A
(1) Kar İşaretili (2) Fan İşaretili
(3) Ampul İşaretili

0.77 \$



CR 204 206
Vidalı 4'lü Geniş Işıklı
Anahtar 16A

0.85 \$

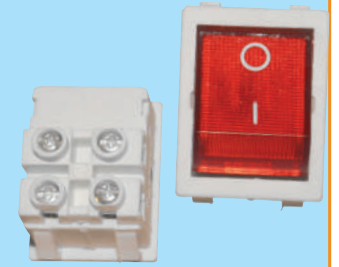

CR 204 207
Klemensli Geniş Işıklı
Difaze Anahtar 16A

0.85 \$



CR 204 208
Geniş Işıklı 1-0-2
Anahtar

1.10 \$



CR 204 209
Geniş Led Işıklı
Difaze Anahtar

1.10 \$



CR 204 301
Geniş Işıklı (1-1)
6 Bağlantılı Anahtar 16A

1.30 \$

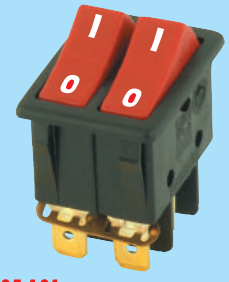

CR 205 101
İkili Işıksız
Anahtar 16A

0.70 \$

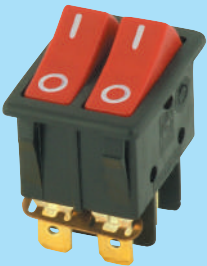

CR 205 102
Kaliteli İkili
Işıksız Anahtar 25A

0.90 \$



CR 205 103
İkili Çift Renkli
Işıksız Anahtar 16A

0.70 \$



CR 205 105
Gri İkili Çift Renkli
Işıksız Anahtar 16A

0.70 \$

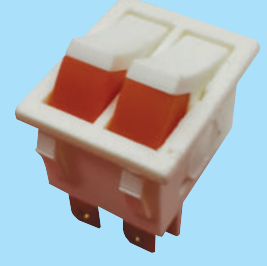

CR 205 106
Beyaz İkili Çift Renkli
Işıksız Anahtar 16A

0.70 \$

ANAHTAR ÇEŞİTLERİ

MICRO SWITCHES

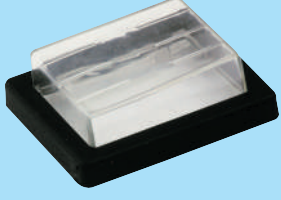

CR 205 130

Çerçevesi Geniş
Anahtar Kılıfı

0.37 \$



CR 205 155

İkili Işıklı
Anahtar 5 soketli 16A

1.00 \$



CR 205 156

İkili Işıklı
Anahtar 6 soketli 16A

1.10 \$



CR 205 157

Kaliteli İkili
Işıklı Anahtar 25A

1.60 \$



CR 205 158

Sarı İkili
Işıklı Anahtar 16A

1.00 \$

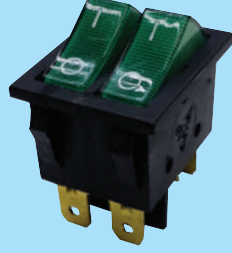

CR 205 159

Yeşil İkili
Işıklı Anahtar 16A

1.00 \$



CR 205 165

İkili Led
Işıklı Anahtar 16A

2.10 \$



CR 206 101

Üçlü Işıksız Anahtar (Bağımsız
Çalışır) Çok Kullanılan 16A

1.10 \$



CR 206 102

Kaliteli 3'lü Işıksız Anahtar
25A (Bağımsız Çalışır)

1.20 \$



CR 206 117

Üçlü Çift Renk Işıksız Anahtar
(Bağımsız Çalışır) 16A

1.10 \$



CR 206 118

Kaliteli Üçlü Çift Renk Işıksız Anahtar
(Bağımsız Çalışır) 25A

1.30 \$

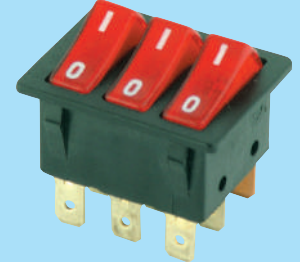

CR 206 127

Üçlü Işıklı
Anahtar 16A

1.50 \$

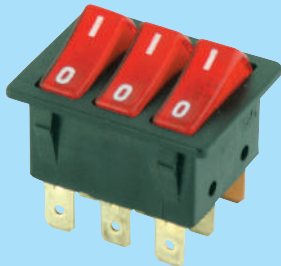

CR 206 128

Kaliteli Üçlü Işıklı
Anahtar 25A

1.80 \$



CR 207 101

Mini Yuvarlak
(0-1) Işıksız Anahtar

0.45 \$



CR 207 105

Mini Yuvarlak Işıklı
Anahtar

0.80 \$



CR 207 115

Yuvarlak 0-1
Anahtar

0.45 \$

ANAHTAR ÇEŞİTLERİ

MICRO SWITCHES



CR 207 116

Yaylı Yuvarlak 0-1
2 Soketli

0.60 \$



CR 207 117

Beyaz Yuvarlak Işıksız Anahtar
(0 - 1) 2 Soketli

0.50 \$



CR 207 118

Yuvarlak 1-0-2
Anahtar

0.60 \$



CR 207 119

Yaylı Yuvarlak
1-0-2 (3 Soketli)

0.90 \$



CR 207 120

Yuvarlak
0-1 Anahtar (3 Soketli)

0.45 \$



CR 207 121

Yuvarlak
0-1 Anahtar (4 Soketli)

0.65 \$



KIRMIZI/SARI/YEŞİL

CR 207 131

Yuvarlak Işıklı
Anahtar 3 Soketli

0.60 \$



CR 207 132

Yuvarlak Işıklı Anahtar
(4 Soketli)

0.85 \$



CR 207 135

Yuvarlak Led Işıklı
Anahtar

0.60 \$



CR 207 148

Oval Işıksız Anahtar
1-0-2

0.60 \$



CR 207 151

Oval Işıksız Anahtar
0-1

0.50 \$



CR 207 153

Oval Işıklı
Anahtar

0.60 \$

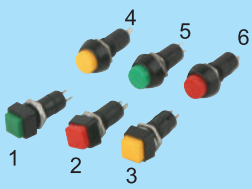

CR 207 301

On / Off
Işıksız Butonlar

0.40 \$

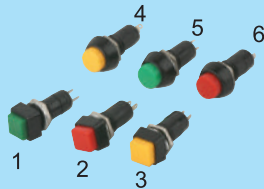

CR 207 302

Light
Yaylı Işıksız Butonlar

0.40 \$



CR 207 311

Metal Light
Işıksız Butonlar

0.60 \$



CR 207 401

Çıt-Çıt Anahtar
1 Paket (100 Ad)

0.25 \$



CR 207 411

Şeffaf Süpürge
Anahtarı

2.00 \$

ANAHTAR ÇEŞİTLERİ

MICRO SWITCHES



CR 207 425

Süpürge Buton
4 Soketli

1.40 \$



CR 207 430

Süpürge Butonu
2 Soketli

1.10 \$

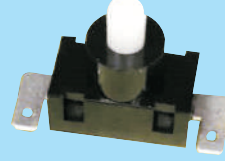

CR 207 435

Süpürge Butonu
2 Soketli

0.65 \$



CR 207 450

Işıksız Süpürge Butonu
4 Soketli

1.50 \$



CR 207 451

Işıklı Süpürge Butonu
4 Soketli

2.00 \$



CR 207 461

Battaniye Anahtarı
1 Kutu : 50 Adet

2.35 \$



CR 207 463

Kablolu Battaniye
Anahtarı

4.20 \$



CR 207 468 6 Soketli 1.10 \$

CR 207 469 8 Soketli 1.20 \$



CR 207 481

Tavan Ventilator Anahtarı
5 Kademe
(Marka ve Model Değişkendir)

10.00 \$



CR 207 501

1+1 Çevirmeli Polyemit Anahtar
(Aç-Kapa-Stoplu)

1.10 \$



CR 207 503

2+2 Çevirmeli
Polyemit Anahtar (Stoplu)

1.50 \$

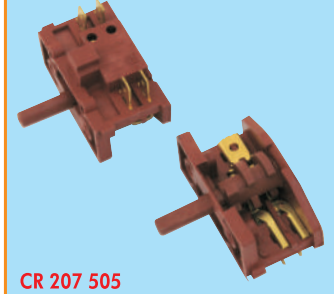

CR 207 505

2+2 Somunlu Çevirmeli
Polyemit Anahtar (Sürekli Döner)

1.50 \$

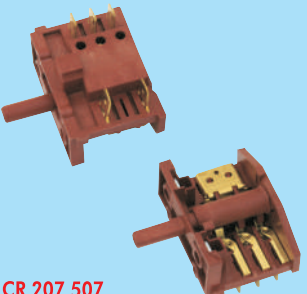

CR 207 507

2+3 Çevirmeli Polyemit
Anahtar (Sürekli Döner)

1.65 \$



CR 207 508

2+3 Çevirmeli Polyemit
Çevirmeli Anahtar (Stoplu)

1.65 \$



CR 207 511

3+3 Çevirmeli Polyemit
Anahtar (Stoplu) Metal / Plastik

1.65 \$



CR 207 512

3+3 Çevirmeli Polyemit
Anahtar (Sürekli Döner)

1.65 \$

ANAHTAR ÇEŞİTLERİ

MICRO SWITCHES



CR 207 516

3+4 Çevirmeli Polyemit Anahtar (Sürekli Döner)

2.00 \$



CR 207 517

4+4 Çevirmeli Polyemit Anahtar (Sürekli Döner) Metal / Plastik

2.00 \$



CR 207 518

4+5 Çevirmeli Polyemit Anahtar (Sürekli Döner) Metal / Plastik

2.60 \$



CR 207 519

5+5 Somunlu Çevirmeli Polyemit Anahtar (Sürekli Döner)

2.60 \$



CR 207 520

5+6 Çevirmeli Polyemit Anahtar (Sürekli Döner)

3.00 \$

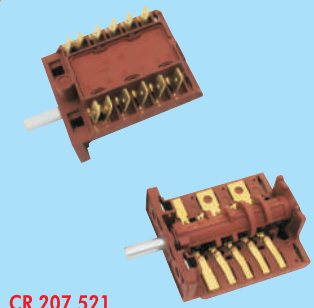

CR 207 521

6+6 Çevirmeli Polyemit Anahtar (Sürekli Döner)

3.00 \$



CR 207 522

6+7 Çevirmeli Polyemit Anahtar (Sürekli Döner)

4.00 \$



CR 207 523

7+7 Çevirmeli Polyemit Anahtar (Sürekli Döner)

4.00 \$



CR 207 524

7+8 Çevirmeli Polyemit Anahtar (Sürekli Döner)

4.00 \$



CR 207 525

8+8 Çevirmeli Polyemit Anahtar (Sürekli Döner)

4.00 \$



CR 208 101

Şofben Anahtarı 2'li

1.10 \$



CR 208 103

Trifaze Şofben Anahtarı

1.70 \$



CR 208 116

3 Soketli Çevirmeli Soba Anahtarı

1.60 \$



CR 208 118

5 Soketli Çevirmeli Soba Anahtarı

1.60 \$



CR 208 121

6 Soketli Çev. Soba Anahtarı

1.60 \$

ANAHTAR ÇEŞİTLERİ

MICRO SWITCHES

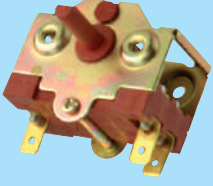

CR 208 125

Çevirmeli Polyemit Fırın Anahtarı 2+1 Soketli

4.70 \$

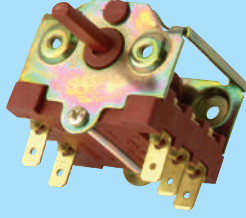

CR 208 126

Çevirmeli Polyemit Fırın Anahtarı 3+2 Soketli

6.00 \$

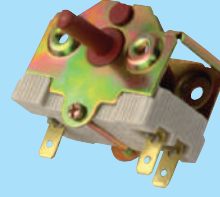

CR 208 127

Çevirmeli Porselen Fırın Anahtarı 2+1 Soketli

5.00 \$

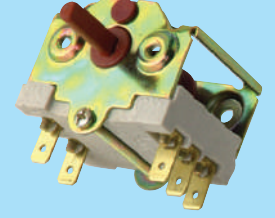

CR 208 128

Çevirmeli Porselen Fırın Anahtarı 3+2 Soketli

7.00 \$

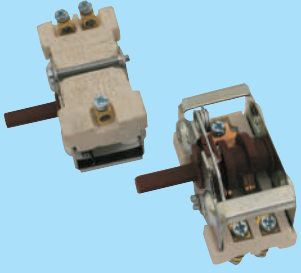

CR 208 130

Çevirmeli Porselen Fırın Anahtarı 2+1 Klemensli

6.00 \$

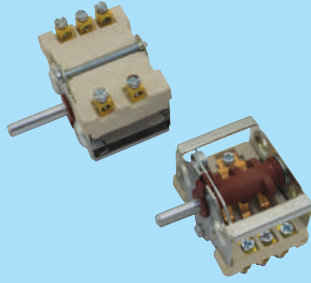

CR 208 131

Çevirmeli Porselen Fırın Anahtarı 3+2 Klemensli

8.00 \$



CR 208 161

Çevirmeli Fırın Anahtarı Düğmesi

0.40 \$



CR 208 171

Şofben Anahtar Düğmesi

0.40 \$



CR 208 172

Arçelik Fırın Düğmesi

1.10 \$



CR 208 173

Arçelik Fırın Düğmesi

1.10 \$



CR 208 175

Ocak Ayar Düğmesi

0.30 \$



CR 208 177

Gazlı Termostat Düğmesi (Ayna+Kapak)
0-40/30-90/30-110/30-120/50-200/50-300

0.40 \$



CR 208 178

Gazlı Köşeli Termostat Düğmesi (Ayna+Kapak)
0-40/30-90/30-110/30-120/50-200/50-300

0.95 \$



CR 208 181

Tas Tipi Dimmer (Işık Ayarlayıcı)

5.00 \$



CR 208 183

Bakalit El Tipi Dimmer (Işık Ayarlayıcı-Renk Değişkendir)

6.50 \$



Anahtarlı Çocuk

Koruma (1) CR 208 195 0.30 \$

Yapışkanlı Çocuk

Koruma (2) CR 208 197 0.28 \$

İMALATIMIZ

ANAHTAR ÇEŞİTLERİ

MICRO SWITCHES



CR 209 101

Tekli Bakalit Anahtar

3.70 \$



CR 209 105

Bakalit Pano Priz

3.70 \$



CR 209 109

İkili Bakalit Anahtar

4.50 \$



CR 210 101

Star-Stop Kumanda Butonu
(Kutu Adeti : 10)

2.00 \$



CR 210 105

Mantar Buton
(Kutu Adeti : 10)

2.20 \$



CR 210 108

Kalıcı Buton
(Kutu Adeti : 10)

3.00 \$



CR 210 139

Mandallı Kalıcı Buton
(Kutu Adeti : 10)

2.30 \$



CR 210 251

Zil Butonu
Yuvarlak

0.80 \$



CR 210 261

Kare
Zil Butonu

0.75 \$

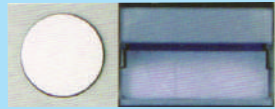

CR 210 281 Etiketli Zil Butonu 0.75 \$

CR 210 285 Işıklı Zil Butonu 1.10 \$

CR 210 295 Sıralı Zil Butonu 1.10 \$

(1 Ad. Fiyatı)

Alüminyum Sıralı
Zil Butonu

CR 210 351	1'li	1.40 \$
CR 210 352	2'li	2.80 \$
CR 210 353	3'lü	4.20 \$
CR 210 354	4'lü	5.60 \$
CR 210 355	5'li	7.00 \$
CR 210 356	6'li	8.40 \$
CR 210 357	7'li	9.80 \$
CR 210 358	8'li	11.20 \$
CR 210 359	9'lu	12.60 \$
CR 210 360	10'lu	14.00 \$
CR 210 361	11'li	15.40 \$
CR 210 362	12'li	16.80 \$

ANAHTAR ÇEŞİTLERİ

MICRO SWITCHES



CR 211 101

Şofben Sivici
(25 A.)

0.65 \$



CR 211 103

Vidalı Şofben
Sivici (25A)

0.80 \$

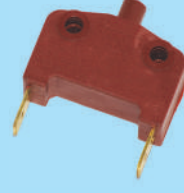

CR 211 105

Şofben Sivici
Yassı (25A)

0.75 \$



CR 211 107

Şofben Sivici
Yassı Vidalı (25A)

0.75 \$



CR 211 108

Şofben Sivici Dikdörtgen
(25A)

1.00 \$

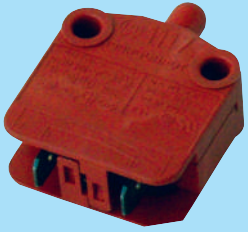

CR 211 115

Soba Sivici
(16A.)

0.60 \$

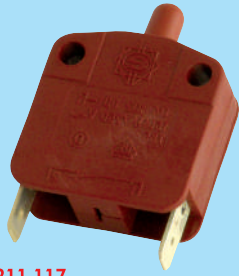

CR 211 117

Ters Dolap
Sivici (16A)

1.00 \$



CR 211 119

4 Soketli - 2 Konumlu
Sivici (16A)

3.75 \$



CR 211 135

Mikro Şofben
Sivici (25A)

2.60 \$

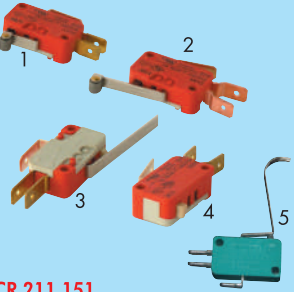

CR 211 151

Mikro Sivici

0.80 \$

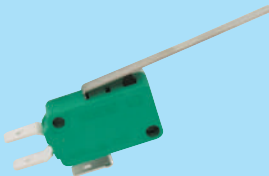

CR 211 152

Mikro Sivici
16A

1.20 \$

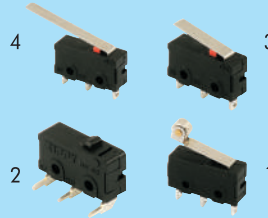

CR 211 162

Mini Mikro
Sivici

0.80 \$



CR 211 201

Denge Sivici

2.20 \$



CR 211 208

İpli Sivici

0.70 \$



CR 211 215

Buharlı Ütü Sivici

3.00 \$

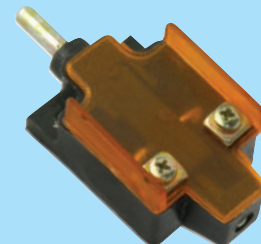

CR 211 217

Pedal Sivici - Sesli (Ütü
Paskalalarında Fanı Çalıştırır)

4.00 \$

ANAHTAR ÇEŞİTLERİ

MICRO SWITCHES

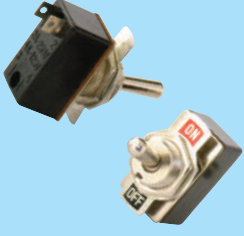

CR 212 100

Metal Sağ-Sol Anahtar
(On-Off) Togo Siviç 2 Bağlantılı

0.90 \$

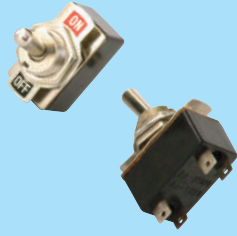

CR 212 101

Metal Sağ-Sol Anahtar
(On-Off) Togo Siviç 4 Bağlantılı

1.00 \$



CR 212 102

Metal Sağ-Sol Anahtar
(On-Off) Togo Siviç 3 Bağlantılı

1.45 \$

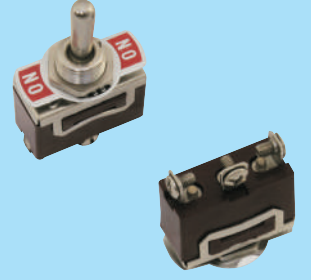

CR 212 103

Metal Sağ-Orta-Sol (On-Of-On)
Togo Siviç 3 Bağlantılı

1.70 \$



CR 212 104

Metal Sağ-Orta-Sol Yaylı
(On-Of-On) Togo Siviç 3 Bağlantılı

1.70 \$

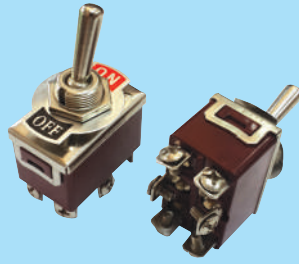

CR 212 105

Metal Sağ-Sol Anahtar
(On-Off) Togo Siviç 6 Bağlantılı

3.30 \$



CR 212 106

Metal Sağ-Sol-Orta (On-Off-On)
Anahtar (Togo Siviç) 6 Bağlantılı

3.80 \$



CR 212 107

Metal Sağ-Sol Yaylı Anahtar (On-Off-On)
Togo Siviç 6 Bağlantılı

3.80 \$



CR 212 141

Sağ-Sol Anahtar
1 Kutu : 25 Ad.

3.50 \$



CR 212 145

Çekme Anahtar
1 Kutu : 25 Adet

1.80 \$



CR 212 147

Sağ-Sol - Orta Anahtar
1 Kutu : 25 Ad.

5.50 \$

TERMOSTAT ÇEŞİTLERİ

THERMOSTATS



CR 301 101

Termovot Termik
10 °C - 80 °C (250V.-15A)

8.00 \$



Termovot Termik - Sunvic

50 °C - 80 °C (240V.-16A) **CR 301 115 25.00 \$**
30 °C - 110 °C (240V.-16A) **CR 301 125 70.00 \$**

CR 301 135

Termovot Termik - Cotherm
40 °C - 80 °C (250V.-20A)

25.00 \$



CR 301 151

Çin Termovot Termik
40 °C - 80 °C

4.60 \$

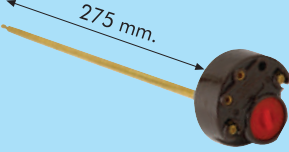

CR 301 153

İtalyan Termovot Termik
40 °C - 80 °C

9.00 \$

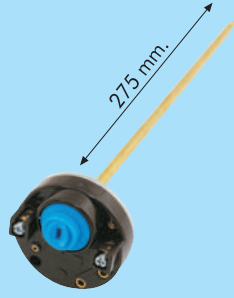

CR 301 157

Türk Termovot Termik
40 °C - 80 °C (Uzun-Standart)

6.00 \$

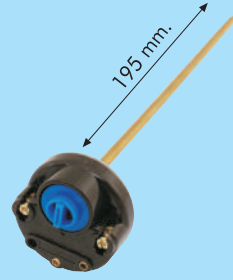

CR 301 158

Türk Termovot Termik
40 °C - 80 °C (Orta Boy)

6.00 \$

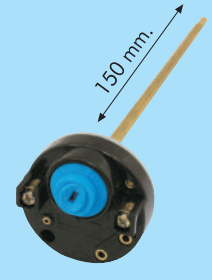

CR 301 159

Türk Termovot Termik
40 °C - 80 °C (Kısa)

6.00 \$

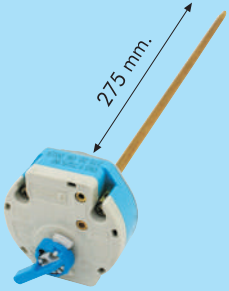

CR 301 161

Türk Ariston
Termovot Termik

9.50 \$



Ütü ve Semaver
Termostatı 10A

CR 301 201 Kısa (1) **1.50 \$**

CR 301 202 Orta (2) **1.50 \$**

CR 301 203 Uzun (3) **1.75 \$**

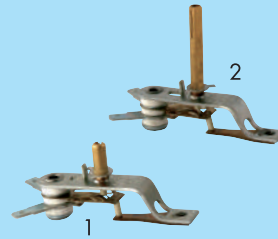

Ütü Termostatı 10A

CR 301 206 Kısa (1)

CR 301 207 Uzun (2)

1.50 \$

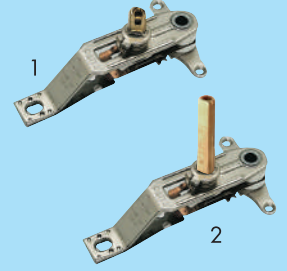

Ütü ve Tost Termostatı 10A

CR 301 208 Kısa (1)

CR 301 209 Uzun (2)

1.85 \$

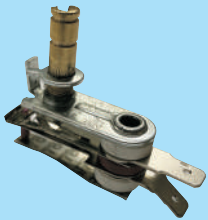

Tost Termostatı

CR 301 211 10A **1.50 \$**

CR 301 212 16A **1.75 \$**

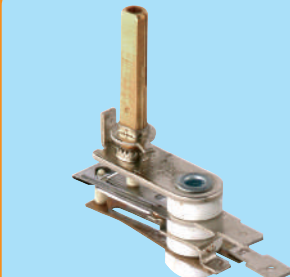

CR 301 213

Akımlı Ocak Termostatı 10A

1.50 \$

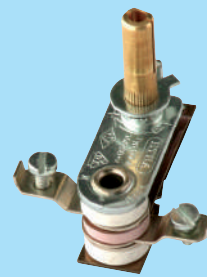

CR 301 215

Sanayi Tip Ütü
Termostatı 10A

1.50 \$

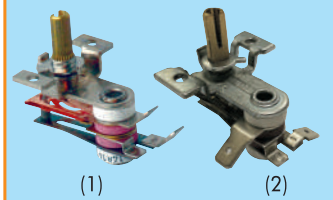

Akımlı Sanayi Ütü
Termostatı (4 Taşlı) 10A

CR 301 219 4 Taşlı (1)

CR 301 221 3 Taşlı (2)

1.50 \$

TERMOSTAT ÇEŞİTLERİ

THERMOSTATS

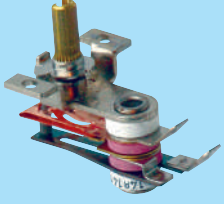

CR 301 222

Akımlı Sanayi Fırın
Termostadı (4 Taşlı) 16A

1.75 \$

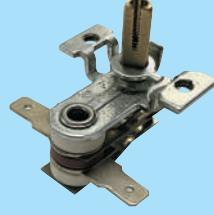

CR 301 223

Soban Fırın v.b.
Termostadı (3 Taşlı) 10A

1.50 \$



CR 301 224

Soban Fırın v.b.
Termostadı (3 Taşlı) 16A

1.75 \$

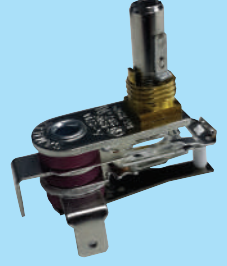

CR 301 228

Somunlu Semaver
Termostadı 10A

2.50 \$



CR 301 231

Lahmacun Makina
Termostadı 10A

1.75 \$



CR 301 235

Akımlı Ocak Termostadı
10A Sac Aparatlı

1.75 \$



CR 301 236

Tost Termostat Akımlı
Alüminyum Aparatlı 10A

1.75 \$

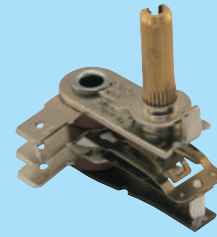

CR 301 237

Topraklamalı Ütü
Termostadı 10A

1.50 \$

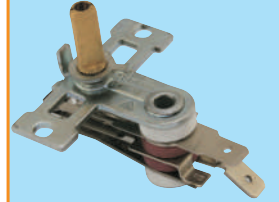

CR 301 238

Büyük Kanatlı Akımlı Cihaz
Termostat 10A

1.75 \$

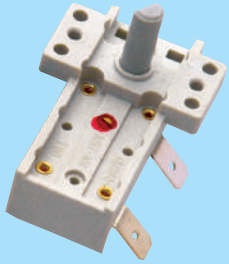

CR 301 351

Radyatör Termostadı
(70 °C)

1.50 \$



CR 301 355

75 °C- 400 °C Gazlı Termostat
Monofaze (Fırınlarda Kullanılır)

8.50 \$



Gazlı-Spiralli Termostat 3 Çıkışlı

CR 301 365 0-40°C (Sobalarda)
CR 301 366 30-90°C (Termosifonlarda)
CR 301 367 30-110°C (Çay Kaz. ve Infrared Sob.)
CR 301 368 30-120°C (Çay Kaz. ve Infrared Sob.)
CR 301 369 50-200°C (Infrared Sobada)
CR 301 370 50-300°C (Kaynak Mak. v.b)

4.50 \$

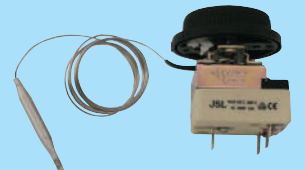

JSL Gazlı-Spiralli Termostat 3 Çıkışlı

CR 301 375 0-40°C (Sobalarda)
CR 301 376 30-90°C (Termosifonlarda)
CR 301 377 30-110°C (Çay Kaz. ve Infrared Sob.)
CR 301 378 30-120°C (Çay Kaz. ve Infrared Sob.)
CR 301 379 50-200°C (Infrared Sobada)
CR 301 380 50-300°C (Kaynak Mak. v.b)

6.00 \$



TECASA POLYEMİT GÖVDE
Gazlı-Spiralli Termostat 2 Çıkışlı

CR 301 385 0-40°C (Sobalarda)
CR 301 386 30-90°C (Termosifonlarda)
CR 301 387 30-110°C (Çay Kaz. ve Infrared Sob.)
CR 301 388 40-120°C (Çay Kaz. ve Infrared Sob.)
CR 301 389 50-200°C (Infrared Sobada)
CR 301 390 50-300°C (Kaynak Mak. v.b)

6.00 \$



TECASA 3 mt PROBLU GAZLI TERMOSTAT

CR 301 391 30-90°C 21.00 \$
CR 301 392 60-190°C 18.00 \$
CR 301 394 50-300°C 10.00 \$

TECASA 1.5 mt PROBLU GAZLI TERMOSTAT

CR 301 397 30-90°C 9.00 \$

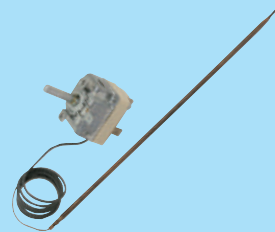

CR 301 399

Ego Tek Problu Monofaze
Gazlı Termostat 50 °C- 500 °C

57.00 \$



CR 301 401

Ego Resetli Trifaze
Gazlı Termostat 235 °C (Tek Problu)

71.00 \$

TERMOSTAT ÇEŞİTLERİ

THERMOSTATS

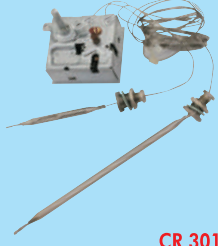

CR 301 405

Ego Çift Problu Somunlu Trifaze Gazlı Termostat +230(-16 °C)

76.50 \$



CR 301 410

Trifaze Tek Problu Gazlı Termostat 50°-300°C (Fritözlerde Kullanılır.)

25.00 \$



CR 301 411

EgoTrifaze Tek Problu Gazlı Termostat 50°-300°C (Fritözlerde Kullanılır.)

71.00 \$

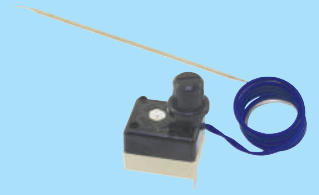

CR 301 425

Emniyet (Limit) Gazlı Termostat 110°C- 230°C-250°C Derece Belirtiniz

11.00 \$



CR 301 428

Emniyet (Limit) Gazlı Termostat 110° (2)

9.00 \$

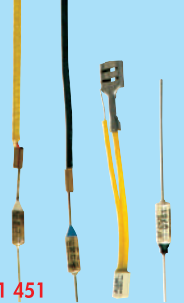

CR 301 451

Termistör Sigortalar (91-105-140-185-216-225-240°C Derece Belirtiniz.)

0.40 \$



CR 301 481

Şofben Termostatı (Küçük)

1.35 \$



CR 301 482

Şofben Termostatı (Büyük)

1.60 \$



Çay Kahve Makina Termikleri (Numune veya Resim veriniz.) Derece Bildiriniz.

50°-160° arası plastik gövde 0.65 \$

CR 301 487

165°-250° arası porselen gövde 1.25 \$

CR 301 488



Resetli Çay Kahve Makina Termikleri Derece Belirtiniz (75-85-90-100-110-135-165°)

Plastik Gövde CR 301 501 2.60 \$

Porselen Gövde CR 301 502 3.30 \$



CR 301 601

Kuluçka Termostatı 0 - 40 °C

35.00 \$



CR 301 611

Mekanik Oda Termostatı 0 - 30 °C

22.00



CR 301 621

Kazan Termostat 0 - 90 °C

26.50 \$



CR 301 651

Dijital Kuluçka Termostatı (Model Değişkendir)

55.00 \$



CR 302 131

Ters Kettle Termik

4.00 \$



CR 302 132

Ters Kettle Ayak

1.25 \$

TERMOSTAT ÇEŞİTLERİ

THERMOSTATS



CR 302 133

Kettle Termik

3.50 \$



CR 302 140

Kettle Termik

3.50 \$



CR 302 142

Kettle Termik

3.50 \$



CR 302 143

Strix Kettle Termik (Orjinal)

8.50 \$

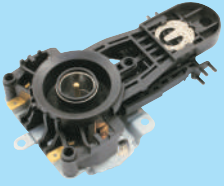

CR 302 145

Kettle Termostatı

4.00 \$

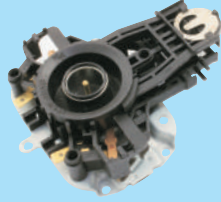

CR 302 147

Kettle Termik

4.00 \$



CR 302 148

Kettle Termik

3.50 \$



CR 302 151

Kettle Termik

1.50 \$



CR 302 181

Kettle Gökbeğ

1.50 \$



CR 302 182

Kettle Gökbeğ

1.50 \$



CR 302 183

Strix Kettle Gökbeğ (Orjinal)

3.00 \$



CR 302 184

Kettle Gökbeğ

1.50 \$



CR 302 185

Yaylı Kettle Termik

1.50 \$



CR 302 186

Kettle Termik

1.50 \$



CR 302 187

Tırnaklı Kettle Termik

1.50 \$



CR 302 188

Tırnaksız Kettle Termik

1.50 \$



CR 302 189

Kettle Termik

1.50 \$

TERMOSTAT ÇEŞİTLERİ

THERMOSTATS



CR 302 190

Kettle Termik

4.00 \$



CR 302 195

Kettle Termik (Birlikte Satılır)

4.50 \$



CR 302 197

Kettle Termik (Birlikte Satılır)

4.00 \$



CR 302 199

Kettle Termik (Birlikte Satılır)

4.00 \$



CR 302 201

Teknograd
Termiği

3.50 \$

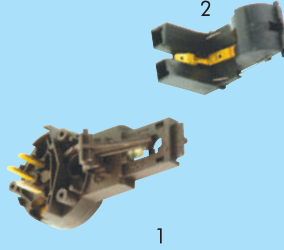

Kettle Termostat (1)

CR 302 375 3.00 \$

Kettle Ayak (2)

CR 302 376 0.50 \$



CR 302 381

Pizzamatik
Termostatı

5.50 \$



CR 302 451

Pakkens Termometre
(Firin Saati-120°C-/5cm.)

8.00 \$



CR 302 455

Çay Kazanı Göstergesi
(Pakkens Termometre
120°1 mt. Spiral)

11.50 \$



CR 302 461

Pakkens Pano Tipi Gösterge
(Bakır Örgülü) 350°C (1 mt.)

21.00 \$



CR 302 462

Pakkens Pano Tipi Gösterge
(Bakır Örgülü) 350°C (2 mt.)

24.00 \$



CR 302 475

500°C Pano Tipi
Termometre

50.00 \$



CR 302 481

Sıvı Ölçer Termometre
(-50 +300°C Arası) (KT-300)

10.00 \$



CR 302 555

Doğalgaz Alarmı

10.00 \$



CR 302 591

Duman Dedektörü

10.00 \$



Dijital Kombi Regülatörü

CR 302 692 (500 VA) 63.00 \$

CR 302 693 (1000 VA) 72.00 \$

KÜÇÜK EV ALETİ PARÇALARI

SMALL APLIANCE PARTS



CR 305 001

Tefal Motor
Dişlisi

0.80 \$



CR 305 002

Tefal 800 Devir
Ara Dişlisi

1.00 \$



CR 305 003

Tefal 1000 Devir
Ara Dişlisi

1.00 \$



CR 305 006

Blue House
Bıçak Dişlisi

1.20 \$



CR 305 007

Blue House
Ara Dişlisi

1.00 \$



CR 305 008

Blue House
Motor Dişlisi

0.80 \$



CR 305 009

Arzum
Ara Dişlisi

1.00 \$



CR 305 010

Arzum
Bıçak Dişlisi

1.20 \$



CR 305 012

Sinbo
Motor Dişlisi

0.80 \$



CR 305 015

Braun
Kavrama Dişlisi

1.60 \$



CR 305 016

Raks
Kavrama Dişlisi

1.20 \$



CR 305 017

Arzum
Kayış Dişlisi

1.60 \$



305 018

Gurups
Karıştırıcı Mili

4.00 \$



CR 305 019

Arzum
Karıştırıcı Mili

4.00 \$

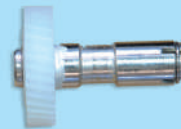

CR 305 020

Arçelik
Mikser Dişlisi

4.00 \$



CR 305 021

Arçelik
Robot Dişlisi

4.00 \$

KÜÇÜK EV ALETİ PARÇALARI

SMALL APLIANCE PARTS



CR 305 022

Rowenta
Robot Kasnağı (Eski)

4.00 \$



CR 305 023

İhlas
Robot Kasnak

4.00 \$



CR 305 024

Rowenta
Robot Kasnak (Yeni)

4.00 \$



CR 305 101

Arzum
Mundo Motor Dişlisi

0.60 \$

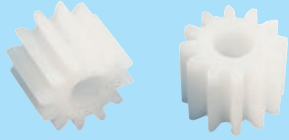

CR 305 102

Arnica - Ovick - Fantom - King
Arzum Rondo Motor Dişlisi

0.60 \$



CR 305 103

Fakir - Asist - Arzum -
Coppo - King - Gold Master
CVS -Rondo Motor Dişlisi

0.60 \$



CR 305 104

Arçelik - Sinbo - King - Beko
Ekmek Makina Dişlisi

1.10 \$



CR 305 105

Arçelik - Tefal - Arzum - Fakir
Ataçman Ara Dişlisi

1.10 \$

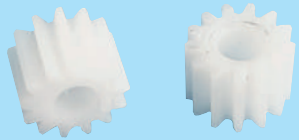

CR 305 106

Sadex - Grovps -Fakir- Raks
CVS Rondo Motor Dişlisi

0.60 \$

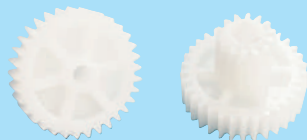

CR 305 107

Arçelik - Arzum - Fakir - Tefal
Philips Blender Çırpıcı Ara Dişlisi

0.60 \$



CR 305 108

Arçelik - Tefal - Arzum - Philips
Rondo Ara Dişlisi

1.10 \$



CR 305 109

Arçelik - Tefal - Arzum - Fakir
Çırpıcı Mil Dişlisi

0.60 \$



CR 305 111

Blender Bıçak Dişlisi
(3. Nesil) No. 11

1.30 \$



CR 305 112

Arzum Arçelik Robot
Motor Dişlisi No. 12

0.65 \$



CR 305 121

Korkmaz Blender
Erkek Dişli No. 1

0.65 \$



CR 305 122

Korkmaz Blender
Erkek Dişli No. 2

0.65 \$

KÜÇÜK EV ALETİ PARÇALARI

SMALL APLIANCE PARTS



CR 305 201

Arçelik
Kavrama Dişlisi

0.40 \$



CR 305 202

Arzum
Kavrama Dişlisi

0.40 \$



CR 305 203

Arzum - CVS - Gold Master - King
Sem Kavrama Dişlisi

0.40 \$



CR 305 204

Arzum -Fakir - Conti -CVS - King
Lider Kavrama Dişlisi

0.60 \$



CR 305 205

Korkmaz
Kavrama Dişlisi

0.40 \$



CR 305 206

Arçelik - Arzum - Philips - Fakir
Vestel - Tefal - Karaca - King
Kavrama Dişlisi

0.40 \$



CR 305 207

Blender Dişlisi
No. 7

0.60 \$



CR 305 208

Blender Dişlisi
No. 8

0.60 \$



CR 305 209

Blender Dişlisi
No. 9

0.60 \$



CR 305 210

Blender Dişlisi
No. 10

0.60 \$



CR 305 375

Blender Motoru
220V DC

17.50 \$



CR 305 401

Rondo Bıçağı - Arnica Quick - Fantom R100
Arzum Presto - Profilo Robo 1100
Aura Magic 1000

8.00 \$



CR 305 402

Homend - Tefal - Arçelik - Beko
Altus - Fakir

8.00 \$



CR 305 403

Arzum - Philips - Felix

8.00 \$



CR 305 404

Arzum Arnica
Prokit 444

12.50 \$

SİNYAL LAMBALARI

SIGNAL LAMPS



CR 401 101

14 mm. Sinyal Lambası
(Kutu Adeti : 50)

0.65 \$



CR 401 113

22 mm. Sinyal Lambası
(Kutu Adeti : 20)

0.70 \$



CR 401 121

Somunlu Soketli Sinyal
Lambası(10 mm)

0.55 \$

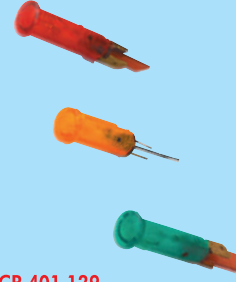

CR 401 129

Soketli Sinyal Lambası
(10 mm) Tırnaklı

0.55 \$

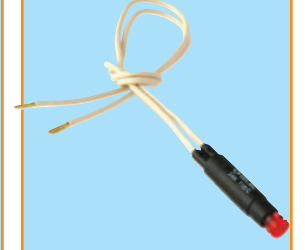

CR 401 137

Kablolu İnce Sinyal
Lambası (8 mm.)

0.40 \$

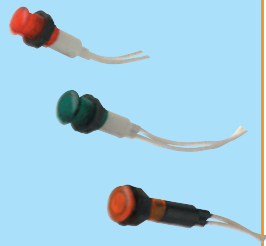

CR 401 145

Kablolu Sinyal Lambası
(10 mm.) Kablolu boyu 15 cm.

0.40 \$



CR 401 155

Kablolu Sinyal Lambası
(10 mm.) Tırnaklı

0.40 \$



CR 402 101

El Feneri Ampülleri
Vidalı 1.5 - 2.5 V.

0.16 \$



CR 402 161

E14 Parfüm Ampül
7W. 220V (Kutu 50Ad.)

0.40 \$



CR 402 165

E14 Renkli
Parfüm Ampül

0.60 \$



CR 402 175

Buzdolabı Ampülü E-14
15W. 220V (Kutu 25Ad.)

0.60 \$



CR 402 177

Dikiş Makinası Ampülü
15W. 220V. (Kutu 50 Ad.)

0.90 \$



CR 402 181

15W Fırın Ampulu 300 °C

1.20 \$



CR 402 185

Aspiratör Ampülü
(1 Kutu 25 Ad.)

2.30 \$

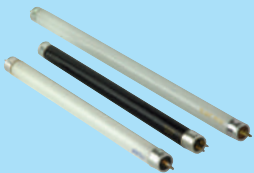

(6W.) Floresant Amp.

CR 402 191

2.80 \$

(8W.) Floresant Amp.

CR 402 195

4.70 \$

(6W.) BLB "(Renkli)"

CR 402 197

4.70 \$

(8W.) BLB "(Renkli)"

CR 402 201

4.70 \$



CR 402 271

Fotoselli Ledli
Gece Lambası

2.20 \$



CR 402 272

Anahtarlı Ledli
Gece Lambası

1.80 \$

KABLOLAR CABLES

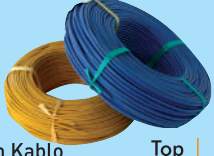

Silikon Kablo (1 Top 100 mt)	Top Fiyatı	Açık Fiyatı
0.75 mm CR 501 111	0.45 \$	0.55 \$
1 mm CR 501 112	0.50 \$	0.60 \$
1.5 mm CR 501 113	0.67 \$	0.90 \$
2.5 mm CR 501 114	1.10 \$	1.40 \$
4 mm CR 501 115	1.65 \$	2.10 \$
6 mm CR 501 116	2.50 \$	3.00 \$

1 metre fiyatıdır / Ağırlık minimum 10 mt.



Silikon Kablo (1 Top 100 mt)	Top Fiyatı	Açık Fiyatı
2x1.5 CR 501 201	3.00 \$	
2x2.5 CR 501 202	5.00 \$	
3x1.5 CR 501 209	4.25 \$	
3x2.5 CR 501 210	6.50 \$	

Siyah ve Kırmızı Renk Belirtiniz

1 metre fiyatıdır



Cam Elyaflı Sil. Kablo (1 Top 100 mt)	Top Fiyatı	Açık Fiyatı
1mm CR 502 110	0.85 \$	1.10 \$
1.5 mm CR 502 111	0.90 \$	1.20 \$
2.5 mm CR 502 112	1.40 \$	1.90 \$
4 mm CR 502 113	2.00 \$	2.70 \$
6 mm CR 502 114	3.20 \$	4.00 \$

1 metre fiyatıdır / Ağırlık minimum 10 mt.



Silikon Makaron (1 Top 100 mt)	Top Fiyatı	Açık Fiyatı
2 mm CR 503 111	0.35 \$	0.45 \$
3 mm CR 503 113	0.35 \$	0.50 \$
4 mm CR 503 115	0.40 \$	0.55 \$
5 mm CR 503 117	0.45 \$	0.60 \$
6 mm CR 503 119 (6 mm Geçmeli Soket İçin)	0.50 \$	0.65 \$

1 metre fiyatıdır / Ağırlık minimum 10 mt.

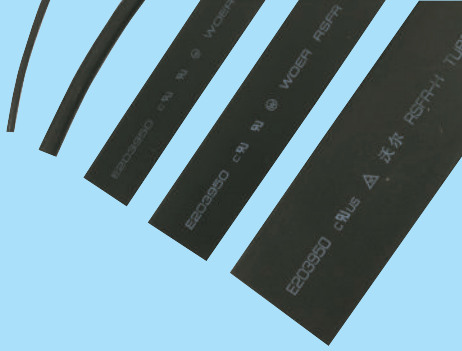

Daralan Makaron	1 Top	Top Fiyatı	Açık Fiyatı
1.5 mm	200m	CR 503 181	0.18 \$ 0.25 \$
2.5 mm	200m	CR 503 183	0.19 \$ 0.26 \$
3 mm	200m	CR 503 184	0.20 \$ 0.26 \$
3.5 mm	200m	CR 503 185	0.22 \$ 0.29 \$
4 mm	200m	CR 503 186	0.26 \$ 0.35 \$
5 mm	200m	CR 503 188	0.30 \$ 0.40 \$
6 mm	200m	CR 503 190	0.35 \$ 0.45 \$
7 mm	100m	CR 503 192	0.45 \$ 0.60 \$
8 mm	100m	CR 503 193	0.47 \$ 0.62 \$
9 mm	100m	CR 503 195	0.48 \$ 0.65 \$

1 metre fiyatıdır / Ağırlık minimum 10 mt.

Daralan Makaron	1 Top	Top Fiyatı	Açık Fiyatı
10 mm	100m	CR 503 201	0.55 \$ 0.70 \$
13 mm	100m	CR 503 208	0.60 \$ 0.80 \$
14 mm	100m	CR 503 211	0.60 \$ 0.80 \$
16 mm	100m	CR 503 221	1.00 \$ 1.30 \$
18 mm	100m	CR 503 231	1.30 \$ 1.70 \$
20 mm	100m	CR 503 241	1.60 \$ 2.00 \$
25 mm	50m	CR 503 245	2.00 \$ 2.60 \$
30 mm	50m	CR 503 251	2.80 \$ 3.70 \$
35 mm	50m	CR 503 261	3.00 \$ 4.00 \$
40 mm	50m	CR 503 263	3.80 \$ 5.50 \$

1 metre fiyatıdır / Ağırlık minimum 10 mt.

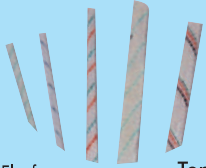

Cam Elyaf Makaron	1 Top	Top Fiyatı	Açık Fiyatı
2 mm 100m	CR 503 265	0.25 \$	-
3 mm 100m	CR 503 267	0.30 \$	-
4 mm 100m	CR 503 269	0.35 \$	-
5 mm 100m	CR 503 271	0.55 \$	-
6 mm 100m	CR 503 273	0.70 \$	-
8 mm 100m	CR 503 275	0.85 \$	-
10 mm 100m	CR 503 278	1.10 \$	-

1 metre fiyatıdır / Açık satışımız yoktur.



H.Class Yüksek Isiya Dayanıklı Cam Elyaf Makaron

1 TOP	Top Fiyatı	Açık Fiyatı
2 mm 200 M	CR 503 325	0.35 \$ 0.50 \$
3 mm 100 M	CR 503 327	0.50 \$ 0.70 \$
4 mm 100 M	CR 503 329	0.70 \$ 1.00 \$
5 mm 100 M	CR 503 331	0.85 \$ 1.20 \$
6 mm 100 M	CR 503 333	1.00 \$ 1.40 \$
7 mm 100 M	CR 503 335	1.25 \$ 1.60 \$
8 mm 50 M	CR 503 337	1.50 \$ 2.00 \$
10 mm 50 M	CR 503 340	1.90 \$ -
12 mm 50 M	CR 503 343	2.40 \$ -
14 mm 50 M	CR 503 347	3.50 \$ -
16 mm 25 M	CR 503 349	4.80 \$ -
18 mm 25 M	CR 503 352	5.00 \$ -
20 mm 25 M	CR 503 355	7.00 \$ -
25 mm 25 M	CR 503 361	11.00 \$ -

1 metre fiyatıdır / Ağırlık minimum 10 mt.

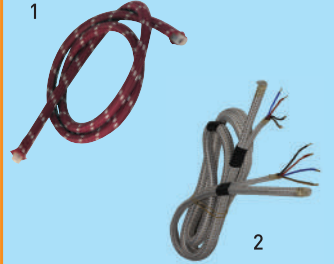

Silikon Buhar Hor. (1 M.) (1) CR 503 501 2.50 \$
Buhar Hortumlu Ütü Kablosu (4x1) 2.50 M.Fiyatıdır. (2) CR 503 505 18.00 \$



Süpürge Kord. - 5m (2x0.75)	CR 504 101	4.20 \$
Süpürge Kord. - 7m (2x0.75)	CR 504 103	5.60 \$
Süpürge Kord. -10m (2x0.75)	CR 504 105	7.80 \$



Balk Sırtı Süp. Kor. 5 mt (2x0.75)	CR 504 106	4.20 \$
Balk Sırtı Süp. Kor. 7 mt (2x0.75)	CR 504 107	5.60 \$
Balk Sırtı Süp. Kor. 10 mt (2x0.75)	CR 504 108	7.80 \$



TTR-Baskılı Kord. - 1.5m. (3x1.5)	CR 504 110	4.00 \$
TTR-Baskılı Kord. - 2m. (3x1.5)	CR 504 111	4.50 \$
TTR-Baskılı Kord. - 3m. (3x1.5)	CR 504 113	6.50 \$
TTR-Baskılı Kord. - 5m. (3x1.5)	CR 504 115	11.00 \$
TTR-Baskılı Kord. - 2m. (3x1)	CR 504 118	4.00 \$
TTR-Baskılı Kord. - 3m. (3x1)	CR 504 120	5.50 \$
TTR-Baskılı Kord. - 2m. (3x2.5)	CR 504 127	7.50 \$
KAUÇUK		
TTR-Baskılı Kord. - 2m. (3x1.5)	CR 504 131	8.50 \$



CR 504 151

Matkap ve Kaynak Mak. Kablosu 2x1,5mm - 4 metre

8.50 \$

KABLOLAR

CABLES



CR 504 161

Ara Paurlı (Anahtarlı) Fişli Kablo
(2x0.50m. - 2mt. Siyah-Beyaz)

2.30 \$



CR 504 175

Tuz Lamba Kablosu
2X0.50 - 2 MT. Siyah / Beyaz

2.50 \$



(1.80m) PVC - Baskılı Ütü Kordonu (3x0.75)-1	CR 504 251	3.00 \$
(2.5m) PVC - Baskılı Ütü Kordonu (3x0.75)-2	CR 504 252	3.80 \$
(1.80m) KAÜÇUK - Baskılı Ütü Kordonu (3x0.75)-1	CR 504 253	4.20 \$
(2.5m) KAÜÇUK - Baskılı Ütü Kordonu (3x0.75)-2	CR 504 254	5.00 \$
Sanayi Tipi (2.5m) KAÜÇUK - Baskılı Ütü Kor. (3x0.75) (Siyah-Kır)-3	CR 504 257	6.00 \$
Sanayi Tipi (2.5m) KAÜÇUK - Baskılı Ütü Kor. (3x1)(Kırmızı)-3	CR 504 259	6.50 \$
Sanayi Tipi (2.5m) KAÜÇUK - Baskılı Ütü Kor. (3x1)(Bordo)-3	CR 504 261	7.00 \$

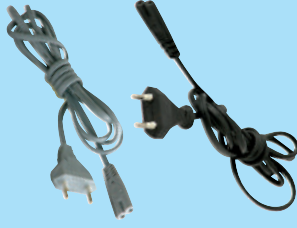

Piyasa Teyp Kordonu (Siyah) **CR 504 291** 0.70 \$
Kaliteli Teyp Kor. (Siyah-Gri) **CR 504 295** 2.20 \$



CR 504 321

Saç Kurutma Kablosu
(2 Metre 2x0.50 mm.)

4.75 \$



CR 504 325

Saç Kurutma Kablosu
(2 Metre 2x0.75 mm.)

2.00 \$



CR 504 331

2x1 2 Metre
Saç Kurutma Kablosu

3.75 \$

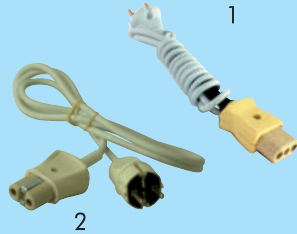

CR 504 341 Topraksız (1) 5.00 \$
CR 504 345 Topraklı (2) 6.00 \$

Ocak Kordonu



CR 504 521

Saç Düzleştirici
Kablo

7.00 \$



CR 504 522

Saç Düzleştirici
Kablo

7.00 \$



CR 504 523

Saç Düzleştirici
Kablo

7.00 \$



CR 504 524

Saç Düzleştirici
Kablo

7.00 \$



CR 504 525

Saç Düzleştirici
Kablo

7.00 \$



CR 504 551

Saç Düzleştirici
Kablo

7.00 \$



CR 504 552

Saç Düzleştirici
Kablo

7.00 \$

KABLOLAR

CABLES

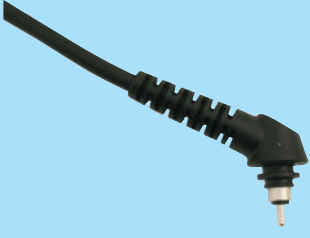

CR 504 553

Saç Düzleştirici
Kablo

7.00 \$

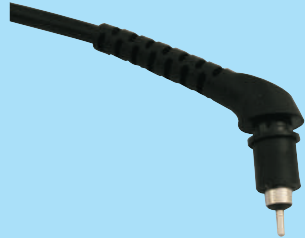

CR 504 554

Saç Düzleştirici
Kablo (Babyliiss Marka)

7.00 \$



CR 504 555

Saç Düzleştirici
Kablo (Braun Marka)

7.00 \$



Bilg. (Power) Kablosu

3x0.75mm-1.50m	CR 505 211	2.30 \$
3x0.75mm-1.80m	CR 505 213	3.50 \$
3x1.5-1.80 m.	CR 505 215	4.50 \$



CR 505 225

Monitör
Ara Kablo

2.50 \$



CR 505 228

Laptop Kablosu (Bakır)

4.00 \$



VGA - VGA KABLO

1,5 mt	CR 505 260	2.60 \$
3 mt	CR 505 261	4.00 \$
5 mt	CR 505 262	6.50 \$
10 mt	CR 505 263	11.00 \$
15 mt	CR 505 264	15.00 \$
20 mt	CR 505 265	22.00 \$
25 mt	CR 505 266	36.00 \$
30 mt	CR 505 267	41.00 \$



Cat-5 Kablo (305 m.) CR 505 281 60.00 \$
Cat-6 Kablo (305 m.) CR 505 283 80.00 \$



Hazır Cat-5 Kablo

CR 505 301	1m	0.90 \$	CR 505 311	15m	4.75 \$
CR 505 303	2m	1.10 \$	CR 505 313	20m	5.80 \$
CR 505 305	3m	1.50 \$	CR 505 315	25m	8.00 \$
CR 505 307	5m	1.85 \$	CR 505 317	30m	10.00 \$
CR 505 309	10m	3.20 \$	CR 505 319	40m	SORUNUZ
			CR 505 321	50m	SORUNUZ



Hazır Cat-6 Kablo

CR 505 322	1m	1.20 \$	CR 505 327	15m	6.50 \$
CR 505 323	2m	1.50 \$	CR 505 328	20m	8.50 \$
CR 505 324	3m	2.00 \$	CR 505 329	25m	10.50 \$
CR 505 325	5m	2.70 \$	CR 505 330	30m	12.00 \$
CR 505 326	10m	4.25 \$			



LCD (HDM) TV Kablosu

CR 505 335	1,5 m	2.30 \$	CR 505 345	20 m	26.00 \$
CR 505 337	3 m	3.50 \$	CR 505 347	25 m	61.50 \$
CR 505 339	5 m	5.00 \$	CR 505 349	30 m	95.00 \$
CR 505 341	10 m	12.50 \$	CR 505 351	40 m	SORUNUZ
CR 505 343	15 m	17.50 \$	CR 505 353	50 m	SORUNUZ



Prop Kablo (Kaliteli) CR 505 385 3.00 \$
Prop Kablo (2.Kalite) CR 505 386 2.00 \$



CR 506 151

Telefon Spirali

1.00 \$



Tekli ve İkili Plug

Telefon Köken Kabl.	1.5m	CR 506 171	0.40 \$
Telefon Köken Kabl.	3m	CR 506 172	0.55 \$
Telefon Köken Kabl.	5m	CR 506 173	0.80 \$
Telefon Köken Kabl.	10m	CR 506 174	1.60 \$



Telefon (Köken) Kablo (2'li) (BAKIR)	
(Siyah - Beyaz - Krem - Gri)	CR 506 195 0.20 \$
Telefon (Köken) Kablo (2'li) (CCA)	
(Siyah - Beyaz - Krem - Gri)	CR 506 215 0.15 \$

1 Top 100 mt.



1 Top 100 mt.

2x0.75 mm² Kordon (BAKIR)	CR 507 151
2x0.75 mm² Kordon (CCA)	CR 507 171

SORUNUZ

ELEKTRONİK ÇEŞİTLERİ

ELECTRONIC PRODUCTS

İMALATIMIZDIR



ÇETİNLER		Koli Adedi/Kutu Adedi		
CR 601 101	Kontrol Kalemi (Klasik Uç)	250	10	2.85 \$
CR 601 102	Kontrol Kalemi (İnce Uç)	250	10	2.85 \$
CR 601 103	Kontrol Kalemi (Yıldız Uç)	250	10	2.85 \$
CR 601 104	Küçük Kontrol Kalemi (Düz)	250	10	2.50 \$
CR 601 105	Küçük Kontrol Kalemi (Yıldız)	250	10	2.50 \$
CR 601 106	Mega Boy Knt. Kal. Klasik Uc	250	10	SORUNUZ
CR 601 107	Mega Boy Knt. Kal. Yıldız Uc	250	10	SORUNUZ

ELEKTİMO		Koli Adedi Kutu Adedi		
CR 601 122	Kontrol Kalemi (İnce Uç)	250	10	1.30 \$
CR 601 123	Kontrol Kalemi (Yıldız Uç)	250	10	1.30 \$
CR 601 124	Küçük Kontrol Kalemi (Düz)	250	10	SORUNUZ
PIYASA				
CR 601 131	Kontrol Kalemi (Düz)			0.60 \$
CR 601 132	Kontrol Kalemi (Yıldız Uç)			0.60 \$
CR 601 133	Küçük Kontrol Kalemi (Düz)			0.60 \$



CR 601 149

Kablo Kontrol Kalemi
(Kablo Kopuğunu Bulur)

3.50 \$



CR 601 151

Volt Ölçer (6V.- 380V.)

10.00 \$



CR 601 153

Pilli Kablo Kontrol Kalemi
(Kablo Kopuğunu Bulur)

7.50 \$



CR 601 155

Uni-t UT-12D Temassız
Kontrol Kalemi

15.00 \$



CR 601 165

Mastech MS-6812
Kablo Test Bili Bili Cihazı

35.00 \$



CR 601 167

Mastech MS-6813
Test Bili Bili Cihazı

115.00 \$



CR 601 181

Küçük Dijital
Avometre

7.00 \$



CR 601 185

Çok Fonksiyonlu Avometre
(ACV+DCV+OHM+A+BUZER
(SES) IŞIK+GENİŞ EKRAN (MY-64L)

40.00 \$



CR 601 191

Büyük - Mekanik Avometre

18.00 \$



CR 601 211

Bilgisayar (CAT-5 Kablo İçin)
(Test Cihazı)

9.00 \$



CR 601 215

Pens Ampermetre (400A)

17.00 \$



CR 601 217

Pens Ampermetre
400A (V+A+OHM+Diyot)
(JT-3266D)

45.00 \$

ELEKTRONİK ÇEŞİTLERİ

ELECTRONIC PRODUCTS



CR 601 219

Pensampermetre
Uni-t UT200A

42.00 \$



CR 601 221

Pensampermetre - UNIT
(V+A+OHM+ C+Diyot+Sürekli Testi)
(AC-400A) Uni-t UT202

55.00 \$



CR 601 255

Uni-T LM60
Lazermetre Mesafe
Ölçer

70.00 \$



CR 601 258

Uni-T UT230B
Wattmetre Fiş Priz
Güç Ölçer

55.00 \$



CR 601 307

UNI-T LM60
Infrared Termometre

43.00 \$



CR 602 171

Skart - Skart

1.75 \$

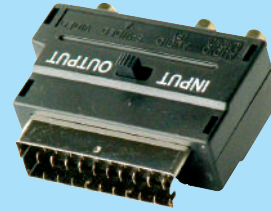

CR 602 185

Skart Adaptör - Siviçi

2.00 \$



CR 602 198

Erkek Power Seyyar

0.90 \$



CR 602 199

Dişi Power Seyyar

0.90 \$



CR 602 201

Power Şase Erkek

0.55 \$



CR 602 202

Power Şase Dişi

0.55 \$

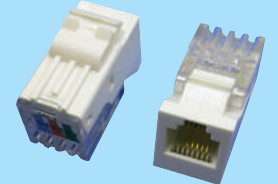

6'lı TELEFON DATA PRİZİ

RJ 11 -6p 6c Keystone Jak CR 603 151 1.10 \$

180 C(Dar) RJ 11 -6p 6c
Keystone Jak CR 603 152 1.20 \$



8'li BİLGİSAYAR DATA PRİZİ

RJ 45 (Cat5) -8p 8c
Keystone Jak CR 603 181 1.10 \$

180 C(Dar) RJ 45 (Cat5)
8p 8c Keystone Jak CR 603 182 1.20 \$



(CAT6 DATA PRİZİ)

(Cat6) -8p 8c
Keystone Jak CR 603 201 1.30 \$

180 C(Dar) (Cat6)
8p 8c Keystone Jak CR 603 202 1.30 \$



Paket 1 Adet Fiyatıdır.

Yak-1 200 CR 603 301 0.04 \$

Yak-2 100 CR 603 302 0.065 \$

Yak-3 100 CR 603 303 0.12 \$



Paket 1 Adet Fiyatıdır.

(2'li) Tlf. Kablo Plug 100 CR 603 351 0.035 \$

(4'lü) Tlf. Spiral Plug 100 CR 603 352 0.04 \$

(6'li) Tlf. Plug 100 CR 603 353 0.055 \$

(8'li) Bilgisayar Plug 100 CR 603 354 0.065 \$

(4'lü) Tlf. Plug 100 CR 603 355 0.05 \$

ELEKTRONİK ÇEŞİTLERİ

ELECTRONIC PRODUCTS



CR 603 381

Cat-6 Plug

0.13 \$



CR 603 382

Yeni Nesil Cat-6 Plug

0.15 \$

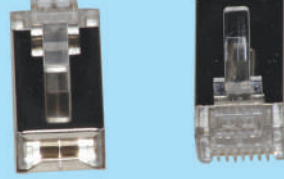

Cat-5 (8'li Shieldli Plug 8p-8c) CR 603 385 0.30 \$

Cat-6 (8'li Shieldli Plug 8p-8c) CR 603 386 0.40 \$



CR 603 511

8'li Plug Kılıfı (Bot)

0.06 \$

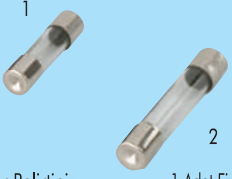

Amper Belirtiniz. 1 Adet Fiyatdır.

Cam Sig. Küçük CR 603 601 0.042 \$
(100'lük Kutu)
1-2-3-4-5-6-7-8-9-10-15-20-25-30A

Cam Sig. Büyük CR 603 631 0.052 \$
(100'lük Kutu) 2
1-2-3-4-5-6-7-8-9-10-15-20-25-30A



Cam Sig. Yuvası CR 603 661 0.32 \$
(Küçük) 1

Cam Sig. Yuvası CR 603 665 0.50 \$
(Büyük) 2
1-2-3-4-5-6-7-8-9-10A

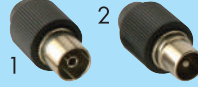

Çin-Erkek/Dişi TV Fişi (1-2 No) CR 603 701 0.30 \$

Oksan-Erkek/Dişi TV Fişi (1-2 No) CR 603 703 0.50 \$



Tekli -LNB (1) CR 604 251 2.90 \$

İkili - LNB (2) CR 604 252 6.50 \$

Dörtlü - LNB (3) CR 604 253 13.00 \$

Sekizli - LNB (4) CR 604 254 28.50 \$



Küçük Krokodil CR 605 151 0.11 \$

Büyük Krokodil CR 605 155 0.17 \$



1 Bağ 10 Ad.

Kablolu Küçük Krokodil CR 605 165 0.30 \$

Kablolu Büyük Krokodil CR 605 168 0.40 \$



Mini Akü Maşası CR 605 170 0.30 \$

Küçük Akü Maşası 7 cm CR 605 171 0.35 \$

Büyük Akü Maşası 10 cm. CR 605 175 0.50 \$



Tekli Telefon Kutusu-1 CR 606 191 0.55 \$

İkili Telefon Kutusu-2 CR 606 192 0.80 \$

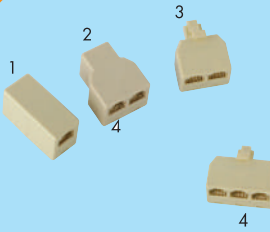

DD-Tel. Dağ.-1 CR 606 211 0.30 \$

DDD-Tel. Dağ.-2 CR 606 212 0.65 \$

EDD-Tel. Dağ.-3 CR 606 213 0.65 \$

EDDD-Tel. Dağ.-4 CR 606 214 0.80 \$

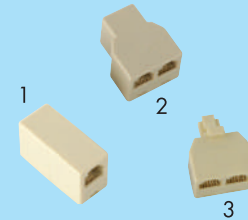

8p-8c Bilg. Ek Kutu (DD) 1 CR 606 231 0.35 \$

8p-8c Bilg. Ek Kutu (DDD) 2 CR 606 232 0.80 \$

8p-8c Bilg. Ek Kutu (EDD) 3 CR 606 233 0.80 \$



CR 606 251

Pos Dağıtıcısı

2.00 \$

ELEKTRONİK ÇEŞİTLERİ

ELECTRONIC PRODUCTS



CR 606 255

5'li Ethernet Siviç
(internet)

27.50 \$



CR 606 265

ADSL Kutu

0.80 \$



CR 606 267

Kaliteli ADSL Kutu

2.75 \$



CR 606 301

Uydu Dağıtıcı
1/2 Siplinter (Kaliteli)

2.50 \$



CR 606 302

Uydu Dağıtıcı
1/3 Siplinter (Kaliteli)

3.00 \$



CR 606 303

Uydu Dağıtıcı
1/4 Siplinter (Kaliteli)

3.30 \$



CR 606 304

Uydu Dağıtıcı
1/6 Siplinter (Kaliteli)

7.00 \$



CR 606 305

Uydu Dağıtıcı
1/8 Siplinter (Kaliteli)

7.50 \$



CR 606 311

Dayzek
(4x1 DISEQ C 2.0 SWITCH)

2.50 \$



CR 606 320

F-Konnektör (Uydu için)
Büyük Delikli (Paket 100 Ad.)

0.05 \$



Kaliteli F-Konnektör
(Uydu için)
(Paket 100 Ad.)

CR 606 321 Büyük Delikli 0.10 \$

CR 606 322 Mega Delikli 0.18 \$



CR 606 323

Küçük Delikli F-Konnektör
(Paket 100 Ad.)

0.16 \$



CR 606 325

Hızlı F-Konnektör
(Paket 100 Ad.)

0.35 \$



F-Ara Konnektör (1) CR 606 331 0.135 \$
F-T- (3'li) Ara Konnektör(2) CR 606 335 0.45 \$



CR 606 341

L Tipi F-Konnektör Dişi-Erkek
(Paket 100 Ad.)

0.65 \$



CR 606 351

BNC Konnektör
(Paket 100 Ad.)

0.60 \$

ELEKTRONİK ÇEŞİTLERİ

ELECTRONIC PRODUCTS



CR 606 371

TV-F Konnektör
(Paket 100 Ad.)

0.40 \$



CR 606 375

Dijital Uydu Konnektör
(Paket 100 Ad.)

0.65 \$



Ayarlı Adaptör 500mA CR 607 153

7.50 \$



12V.1A	CR 607 291	3.00 \$
12V.2A	CR 607 292	4.00 \$
12V.3A	CR 607 293	13.50 \$
12V.5A	CR 607 294	17.00 \$
12V.7A	CR 607 295	19.50 \$

Plastik Kasa Adaptör
(Şerit Led - Seslendirme vb.Kullanılır.)



CR 608 151

Soketli

Işıldak Aküsü (6V.) 4A
(1Kutu:20Ad.)

9.50 \$



CR 608 153

12V. 2,2A Akü
(Oyuncak Araba, Süpürge
Vb.Kullanılır.)

21.00 \$



CR 608 155

Dar 6V.- 2.8A
Ledli Işıldak Aküsü

14.00 \$



CR 608 171

Bilgisayar Aküsü (12V. - 7A.)

22.00 \$



CR 608 173

4 Volt 5 Amper Akü

17.00 \$



CR 608 174

6 Volt 12 Amper Akü

30.00 \$



CR 608 175

6 Volt 7 Amper Akü

23.00 \$



CR 608 176

12 Volt 1.3 Amper Akü

15.00 \$



CR 608 177

12 Volt 9 Amper Akü

40.00 \$



CR 608 178

12 Volt 4.2 Amper Akü

30.00 \$

ELEKTRONİK ÇEŞİTLERİ

ELECTRONIC PRODUCTS

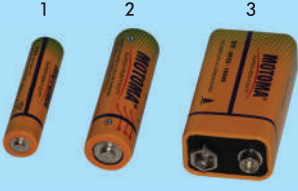

1
Kutu

AAA İnce Kalem Pil (1)	60	CR 608 201	0.15 \$
AA Kalem Kalem Pil (2)	60	CR 608 202	0.15 \$
9V Yassı Pil (3)	10	CR 608 203	1.00 \$

Marka Değişkendir

1 Adet Fiyatdır



1
Kutu

GP AA İnce Kalem Pil	40	CR 608 211	0.70 \$
GP AA Kalem Pil	40	CR 608 212	0.70 \$
GP 9V Yassı Pil Tekli	10	CR 608 213	3.00 \$

1 Adet Fiyatdır



GP ReCyko 1000mAh AAA Şarjlı Pil	CR 608 215	3.50 \$
GP ReCyko 2700mAh AA Şarjlı Pil	CR 608 219	5.50 \$
GP ReCyko 200mAh Tekli 9V Şarjlı Pil	CR 608 221	13.00 \$

1 Adet Fiyatdır



GP ReCyko Pro	1500 defa şarj edilebilir.
800mAh AA Şarjlı pil	CR 608 225 3.00 \$
2000mAh AA Şarjlı pil	CR 608 227 4.75 \$

1 Adet Fiyatdır



CR 608 230	GP A76 LR44 -1,5V Para Pil	1.40 \$
5'li kart fiyatıdır.		
CR 608 231	GP CR1220 3V Para Pil	5.00 \$
CR 608 232	GP CR1620 3V Para Pil	7.50 \$
CR 608 233	GP CR2016 3V Para Pil	3.00 \$
CR 608 234	GP CR2025 3V Para Pil	3.00 \$
CR 608 235	GP CR2032 3V Para Pil	3.00 \$
CR 608 236	GP CR1616 3V Para Pil	5.00 \$
CR 608 237	GP CR2430 3V Para Pil	12.50 \$

5'li kart fiyatıdır.



CR 608 242	CR 608 243
GP 23A, 12V Yüksek Voltaj Alkalın Pil	CR 608 242 0.80 \$
GP 27A, 12V Yüksek Voltaj Alkalın Pil	CR 608 243 1.00 \$

1 Adet Fiyatdır



2'li Şarjlı Süpürge Pili (1-2)	CR 608 251	7.50 \$
3'lü Şarjlı Süpürge Pili (3-4)	CR 608 255	11.50 \$



CR 610 151

Amerikan Fiş

0.50 \$



CR 610 158

Yassı Uçlu Amerikan Fiş

0.65 \$



CR 610 171

İngiliz Adaptör Fiş
(1 Kutu 50 Adet)

0.80 \$

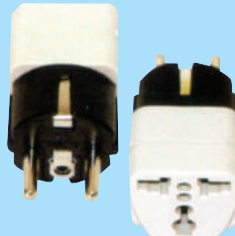

CR 610 181

Üniversal Fiş
(1 Kutu 50 Adet)

1.10 \$



CR 610 191

Multi Üniversal Fiş
(Çok Amaçlı)

8.50 \$



CR 610 201

İngiliz Erkek Fiş

3.20 \$

ELEKTRONİK ÇEŞİTLERİ

ELECTRONIC PRODUCTS



CR 610 202

İngiliz Üniversal Fiş

2.50 \$



Jaklı Telefon Fişi (Çin) CR 610 205 0.90 \$
Yerli Jaklı Telefon Fişi CR 610 207 0.90 \$



CR 611 151

İkili Pil Yuvası

0.32 \$



CR 611 153

9V. Pil Başlığı

0.18 \$



CR 611 155

Dörtlü Pil Yuvası

0.65 \$



CR 611 171

Deney Seti

1.20 \$

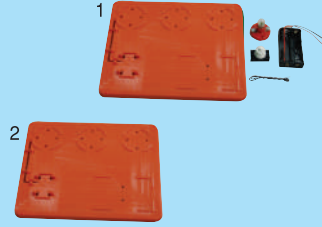

Deney Seti-Aparatlı (1) CR 611 175 2.10 \$
Deney Seti
Montaj Aparatı (2) CR 611 177 0.45 \$



CR 611 183

Tahtalı Ampül Deney Seti

1.20 \$



CR 611 185

Tahtalı Pervaneli
Motor Deney Seti

1.50 \$

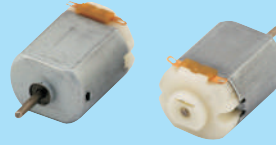

CR 611 191

1.5 V Deney Motoru

0.60 \$

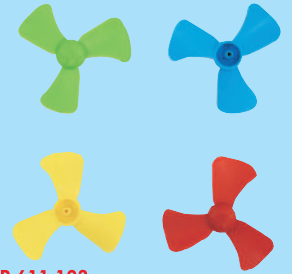

CR 611 193

Deney Pervanesi
Pervane Çapı 60 mm.

0.10 \$



CR 611 194

Büyük Deney Pervanesi
Pervane Çapı 100 mm.

0.60 \$

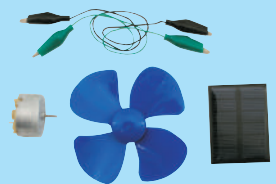

CR 611 201

Güneş Panelli Motor
Devresi

8.50 \$



CR 611 209

Küçük Motorlu Rüzgar
Gülü Devresi

6.00 \$

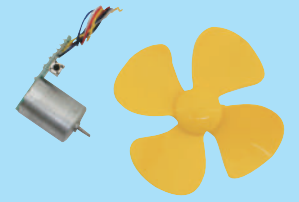

CR 611 211

Büyük Motorlu Rüzgar
Gülü Devresi

6.00 \$

ELEKTRONİK ÇEŞİTLERİ

ELECTRONIC PRODUCTS

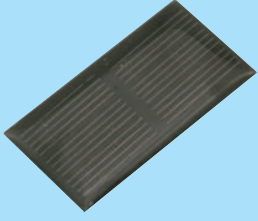

CR 611 225

Güneş Paneli 52x27mm
1,5 V 100 mA

2.50 \$

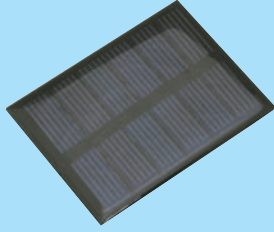

CR 611 227

Güneş Paneli 60x45 mm
4.2 V 100 mA

6.50 \$

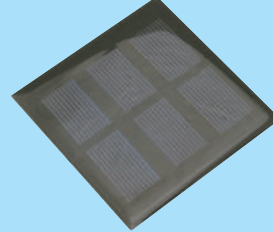

CR 611 229

Güneş Paneli 70x70 mm
1.5 V 250 mA

5.50 \$

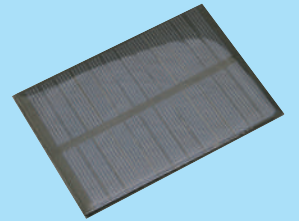

CR 611 231

Güneş Paneli 69x100 mm
6 V 150 mA

15.00 \$

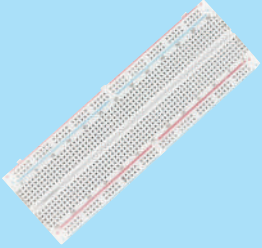

CR 611 241

Bread Board Lehimsiz
Devre Kurma Tahtası

3.00 \$

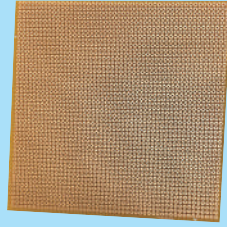

CR 611 251

Delikli Deney Plaketi
12.5 x 12.5 cm.

2.75 \$

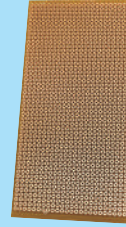

CR 611 254

Delikli Deney Plaketi
6.25 x 12.5 cm.

1.30 \$

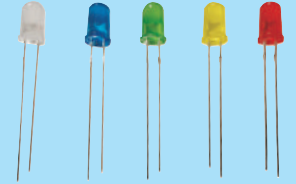

CR 611 258

1,5 V Öğrenci Ledi

0.04 \$



Ekonomik İnce Uç Havya

CR 612 111	40W	6.25 \$
CR 612 113	60W	7.00 \$

2.00 \$



İnce Uç Havya

CR 612 165	30W	14.00 \$
CR 612 167	40W	14.00 \$
CR 612 169	60W	16.00 \$
CR 612 175	100W	21.50 \$

2.50 \$



CR 612 176

Havya Ucu
100 W

6.00 \$

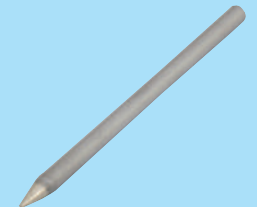

CR 612 177

Havya Ucu
60 W

3.50 \$



CR 612 178

Havya Ucu
30-40 W

2.00 \$

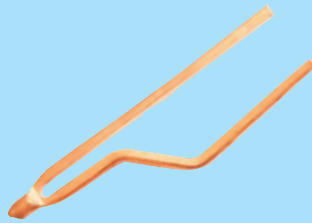

CR 612 180

Sonar Tabanca Havya Ucu
100 W

2.50 \$



Sanayi Tipi Havya 150W	CR 612 185	52.00 \$
Sanayi Tipi Havya 200W	CR 612 187	60.00 \$
Sanayi Tipi Havya 300W	CR 612 189	80.00 \$



CR 612 201

Tabanca Havya - SONAR
100W - 220V

30.00 \$

ELEKTRONİK ÇEŞİTLERİ

ELECTRONIC PRODUCTS



CR 612 211

Ucuz Tabanca Hava
40W

15.00 \$



CR 612 219

Analog Hava Isı Ayarlı
(150-450°C)

52.00 \$



CR 612 221

Isı Ayarlı Hava
Class 936A Analog

65.0 0 \$



CR 612 222

Isı Ayarlı Hava
Class 938A Dijital

87.00 \$



CR 612 226

Ahşap ve Deri Yakma
Isı Ayarlı Hava (450-750°C)

82.00 \$



CR 613 151

Lehim Pompası

3.00 \$



Pinax Tüp Lehim
1 Kutu 50 Ad. (1) CR 613 171 1.10 \$
Solder Tüp Lehim
Kaliteli (2) CR 613 175 6.20 \$



Soldex Lehim Teli (60/40)
Kalınlık 0,75 mm

CR 613 177 200 gr 25.00 \$
CR 613 178 500 gr 60.00 \$



60/40 Soldex Makara Lehim
Kalınlık 1.20 mm

CR 613 185 200 gr 23.00 \$
CR 613 195 500 gr 57.00 \$

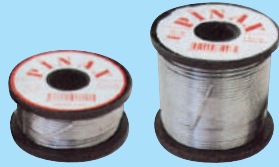

200 gr. 500 gr.

30/70Pinax Makara Lehim
Kalınlık 1.60 mm.

CR 613 205 200 gr 13.50 \$
CR 613 215 500 gr 32.50 \$



CR 613 251

Lehim Pastası
1 Kutu 48 Ad.

1.00 \$



CR 613 262

Löflett Lehim Pastası 50 gr.
1 Kutu 48 Ad.

4.00 \$



CR 613 271

Hava Set

7.00 \$



CR 613 281

Hava Sehpa

4.00 \$



Sıcak Silikon (1 kg)

CR 614 151 Kalın 14.50 \$
CR 614 153 İnce 21.00 \$



CR 614 161

Sıcak Silikon Tabancası

10.50 \$

ELEKTRONİK ÇEŞİTLERİ

ELECTRONIC PRODUCTS



CR 614 185

Sıcak Hava Tabancası
(Daralan Makaron vb. Büzüşmesinde kullanılır.)

47.00 \$



CR 615 148

Yeni Nesil Cat-6
Plug Pensesi

32.00 \$



CR 615 157

Kaliteli İkili Pense (6p 6c+8p 8c)
2-4-6-8'li Plug Basar

50.00 \$



CR 615 159

Üçlü Pense (8p 8c-6p 6c-4p 4c)
2-4-6-8'li Plug ve Telf.
Spiral Plug Basar

13.00 \$



CR 615 168

Dişi Terminal (6.3 mm)
Sıkma Pensesi
(Renk Değişkendir)

82.00 \$



CR 615 171

İzoleli Kablo Ucu Sıkma
Pensesi

75.00 \$



CR 615 175

Kablo Yüksük Pensesi

145.00 \$



CR 615 181

Kablo Ucu Açma Pensesi

21.00 \$



CR 615 191

Kep Kep
İrtibatlama Aleti

7.00 \$



Diyafon Merkezi 1'li CR 616 140 32.50 \$
Diyafon Merkezi 2'li CR 616 141 34.50 \$
Diyafon Merkezi 3'lü CR 616 142 36.00 \$
Diyafon Merkezi 4'lü CR 616 143 38.50 \$



CR 616 151

Diyafon Şubesi
(Marka ve Model Değişkendir)

6.00 \$

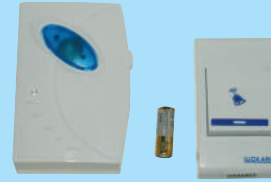

CR 616 171

Kumandalı Kapı Zili
(Marka ve Model Değişkendir)

7.00 \$



CR 616 178

Telefon Zili (Ayarlı) 12V

4.70 \$



CR 616 181

Ding Dong Elektronik Kapı Zili
12 V

4.25 \$



CR 616 183

Elektronik Melodili Zil

4.70 \$



Tek Sesli Kanarya Zil 12V CR 616 191 2.75 \$
Üç Sesli Kanarya Zil 12V CR 616 195 4.25 \$



CR 616 198

12-240 V
Ding Dong Zil

4.25 \$

ELEKTRONİK ÇEŞİTLERİ

ELECTRONIC PRODUCTS



CR 616 205

220 V
Kanarya Zil

2.75 \$



CR 616 301

Zil Trafosu
220V - 15 V

7.30 \$



CR 616 311

Zaman Ayarlı Merdiven Işık
Otomatığı (20sn-5dakika)

9.00 \$



CR 616 323

Butonlu
Kapi Otomatığı

15.50 \$

ELEKTRİKLİ ALETLER

ELECTRICAL APPLIANCES



Kromajlı Su Isıtıcı 220V. 1500W (Topraklı)
(1Kutu: 50Ad.) **CR 701 151** 3.00 \$
Kromajlı Su Isıtıcı 220V. 1500W (Topraksız)
(1Kutu: 50Ad.) **CR 701 152** 2.55 \$
Tavsiye Etmiyoruz



CR 701 153

Kaliteli Krom Su Isıtıcı
220V 1500W (1 Kutu 50 adet)

5.00 \$



Anahtarlı Küçük Izgara	CR 702 151	32.00 \$
Anahtarlı Büyük Izgara	CR 702 153	35.00 \$
Anahtarlı Mega Izgara	CR 702 155	39.00 \$

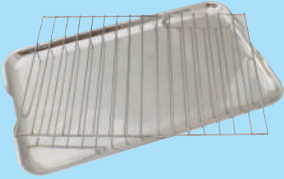

Taner Marka İçindir

Küçük Izgara Tepsisi **CR 702 157** 5.50 \$
Büyük Izgara Tepsisi **CR 702 158** 6.00 \$
Mega Izgara Tepsisi **CR 702 159** 6.50 \$



Mini Kebabçı Izgara **CR 702 161** 55.00 \$
Büyük Kebabçı Izgara **CR 702 162** 62.00 \$



Çay Kazanı 40 BRD	CR 702 201	75.00 \$
Çay Kazanı 60 BRD	CR 702 203	85.00 \$
Çay Kazanı 80 BRD	CR 702 205	95.00 \$
Çay Kazanı 120 BRD	CR 702 208	100.00 \$
Çay Kazanı 160 BRD	CR 702 212	110.00 \$
Çay Kazanı 250 BRD	CR 702 222	125.00 \$

Model ve Marka Değişkendir.



CR 702 241

Elektrikli Cezve 1000W 230V
(Kahve için ideal)

13.50 \$



CR 703 151

Banyo Elektrikli Ani Su Isıtıcı
(Marka Değişkendir)

SORUNUZ



CR 703 163

CR 703 161

CR 703 161 Ani Su Isıtıcı Duş Hortumu 2.20 \$
CR 703 163 Ani Su Isıtıcı Ahize+ Vidalar 4.00 \$



CR 703 165

Mutfak Tipi Elektrikli
Ani Su Isıtıcı

SORUNUZ

ELEKTRİKLİ ALETLER

ELECTRICAL APPLIANCES



CR 703 251 32 inc. TV Seh. 5.50 \$
CR 703 255 50 inc. TV Seh. 7.50 \$
CR 703 257 65 inc. TV Seh. 9.50 \$



TV Duv. Askı Aparatı
CR 703 265 27 HA 10.50 \$
CR 703 266 32 HA 13.00 \$



CR 703 271
TV Tavan Askı Aparatı
(70-110 cm. arası)

36.00 \$



CR 704 131
Elektrikli Közmatik
(Model Değişkendir)

12.00 \$



Borulu Ocak 220 V 1000W
CR 704 141 KARE 21.00 \$
CR 704 144 YUVARLAK 11.00 \$

12.00 \$



CR 704 151
Mini Pleytli Ocak
350W - 220V

26.00 \$



CR 704 156
Pleytli Boyalı Ocak
1000W-220V. (1 Koli 10 Ad.)

30.00 \$



CR 704 157
Pleytli Boyalı Ocak
1500W-220V. (1 Koli 6 Ad.)

35.00 \$



CR 704 161
İkili Pleytli Boyalı Ocak
1000+1500W-220V. (1 Koli 5 Ad.)

58.00 \$

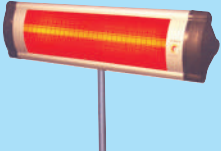

Fiyatlara
Ayak
Dahil
Değildir.

2000W İnfrared Soba CR 705 157
2500W İnfrared Soba CR 705 159
3000W İnfrared Soba CR 705 161

SORUNUZ

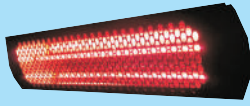

CR 705 163
İnfrared Dış Mekan Isıtıcı

SORUNUZ



CR 705 165
1)Sabit İnfrared Ali. Soba Ayacı 6.00 \$
CR 705 167
2)Teleskobik İnfrared Soba Ayacı SORUNUZ

SORUNUZ

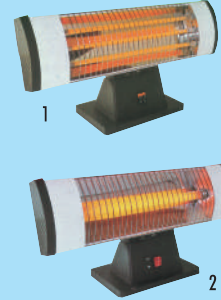

CR 705 171 1) 3 Camlı Soba
CR 705 175 2) İnfrared - Tek Camlı Soba

SORUNUZ

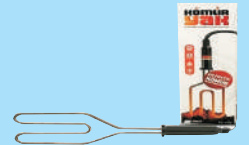

CR 705 192
Kömür Yak 220V.

12.00 \$



CR 705 201
Fanlı Soba

SORUNUZ



4800W Monofaze Elk. Fanlı Isıtıcı CR 705 251
10000W Trifaze Elk. Sanayi Tipi Fanlı Isıtıcı CR 705 255

SORUNUZ



CR 706 101
Masa Üstü Vantilatör
(Marka Model Değişkendir)

SORUNUZ



CR 706 105
Ayaklı Vantilatör
(Marka Model Değişkendir)

SORUNUZ



CR 706 121
Tavan Tipi Vantilatör
(Marka Model Değişkendir)

SORUNUZ

SOKET TERMİNAL ÇEŞİTLERİ

SOCKETS AND TERMINALS

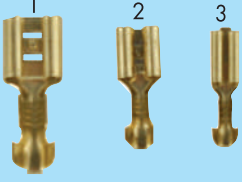

Geçmeli Dişi Terminal (1) (Çok Kullanılan) 250 Ad.) (6.3 mm)	CR 801 151	0.03 \$
Küçük Geçmeli Dişi Terminal (2) (500 Ad.) (4.8 mm)	CR 801 152	0.025 \$
Mini Geçmeli Dişi Terminal (3) (1000 Ad.) (2.8 mm)	CR 801 153	0.025 \$

1 Adet Fiyatıdır.

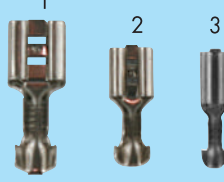

Geçmeli Krom Dişi Terminal (1) (Çok Kullanılan) (250 Ad.) (6.3 mm)	CR 801 161	0.020 \$
Küçük Geçmeli Krom Dişi Terminal (500 Ad.) (4.8 mm) (2)	CR 801 162	0.016 \$
Geçmeli Krom Dişi Terminal (3) (1000 Ad.) (2.8 mm)	CR 801 163	0.012 \$

1 Adet Fiyatıdır.

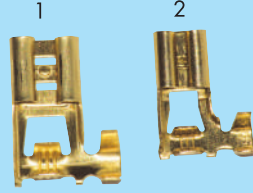

Yan Geçmeli Dişi Terminal (1) (250 Ad.) (6.3 mm)	CR 801 171	0.033 \$
Küçük Yan Geçmeli Dişi Terminal (500 Ad.) (4.8 mm) (2)	CR 801 172	0.028 \$

1 Adet Fiyatıdır.



CR 801 181		
İkili - Dişi ve Erkek Terminal (6.8 mm) (1. Pk: 100 Ad.)		0.06 \$

1 Adet Fiyatıdır.



Küçük Delikli Topraklama Terminali (500 Ad.) 4.2 mm. (1)	CR 801 185	0.02 \$
Delikli Topraklama Terminali (Çok Kullanılan) 4.2mm (250 Ad.) (2)	CR 801 187	0.025 \$
Delikli Topraklama Terminali 5mm (250 Ad.) (3)	CR 801 189	0.04 \$

1 Adet Fiyatıdır.



Delikli Topraklama (Ufo için) Terminal 6 mm. (250 Ad.) (4)	CR 801 192	0.06 \$
Delikli Topraklama Terminal 8 mm. (150 Ad.) (5)	CR 801 195	0.07 \$
Delikli Topraklama Terminal 10 mm. (100 Ad.) (6)	CR 801 198	0.08 \$

1 Adet Fiyatıdır.

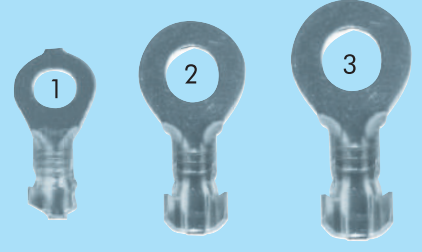

Krom Delikli Topraklama Terminali (Çok Kullanılan) 4,2 mm. (500 Ad.)-1	CR 801 211	0.020 \$
Krom Delikli Top. Ter. (5mm) (500 Ad.)-2	CR 801 212	0.020 \$
Krom Delikli Top. Ter. (6mm) (250 Ad.)-3 (Ufo Tipi Sobada Kullanılan)	CR 801 213	0.025 \$

1 Adet Fiyatıdır.



Ay Terminal 1 No: (500 Ad.)	CR 801 221	0.03 \$
Ay Terminal 2 No: (250 Ad.)	CR 801 223	0.04 \$
Ay Terminal 3 No: (250 Ad.)	CR 801 225	0.065 \$
Ay Terminal 4 No: (150 Ad.)	CR 801 227	0.09 \$

1 Adet Fiyatıdır.

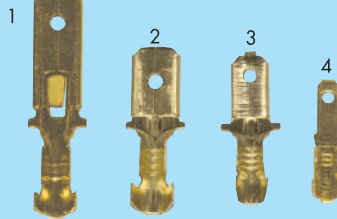

Erkek Ter. Uzun (6.3 mm) (1)	250 Ad.	CR 801 241	0.04 \$
Erkek Ter. Kısa (6.3 mm) (2)	250 Ad.	CR 801 242	0.03 \$
Erkek Ter. Küçük (4.8 mm) (3)	250 Ad.	CR 801 243	0.025 \$
Erkek Ter. Mini (2.8 mm) (4)	500 Ad.	CR 801 244	0.025 \$

1 Adet Fiyatıdır.



Kablo Ucu Terminali (500 Ad.) (Paslanmaz-1/Pirinç-2)		
CR 801 255 1) Krom		0.01 \$
CR 801 256 2) Pirinç / Sarı		0.03 \$

1 Adet Fiyatıdır.

SOKET TERMİNAL ÇEŞİTLERİ

SOCKETS AND TERMINALS



İZOLELİ DELİKLİ TERMİNAL 0.5 - 1.5 mm.

Kutu Adeti

M4	200	CR 801 301	0.045 \$
M5	200	CR 801 302	0.045 \$
M6	200	CR 801 303	0.07 \$
M8	200	CR 801 304	0.07 \$

1 Adet Fiyatdır.



İZOLELİ DELİKLİ TERMİNAL 1.5-2.5 mm.

Kutu Adeti

M4	200	CR 801 311	0.055 \$
M5	200	CR 801 312	0.055 \$
M6	200	CR 801 313	0.077 \$
M8	200	CR 801 314	0.077 \$
M10	200	CR 801 315	0.077 \$

1 Adet Fiyatdır.



İZOLELİ DELİKLİ TERMİNAL 4-6 mm.

Kutu Adeti

M4	100	CR 801 321	0.12 \$
M5	100	CR 801 322	0.12 \$
M6	100	CR 801 323	0.13 \$
M8	100	CR 801 324	0.16 \$
M10	100	CR 801 325	0.165 \$
M12	100	CR 801 326	0.165 \$

1 Adet Fiyatdır.

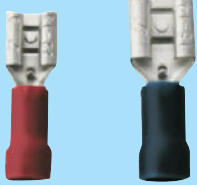

İZOLELİ GEÇMELİ TERMİNAL

Kutu Adeti

4.8 mm	200 Adet	CR 801 341	0.04 \$
6.3 mm	200 Adet	CR 801 342	0.055 \$

1 Adet Fiyatdır.



İZOLELİ YÜKSÜK

Kutu Ad.

1 Adet Fiyatdır.

0.50 mm	1000 Ad.	CR 801 351	0.01 \$
0.75 mm	1000 Ad.	CR 801 352	0.01 \$
1.00 mm	1000 Ad.	CR 801 353	0.01 \$
1.50 mm	1000 Ad.	CR 801 354	0.01 \$
2.50 mm	500 Ad.	CR 801 355	0.013 \$
4.00 mm	500 Ad.	CR 801 356	0.022 \$
6.00 mm	250 Ad.	CR 801 357	0.03 \$
10.00 mm	100 Ad.	CR 801 358	0.037 \$
16.00 mm	100 Ad.	CR 801 359	0.053 \$



CR 802 151

1 Ad. Fiyatdır

Terminal - Soket Kılıfı - Plastik (6.3mm)
1 Paket : 300 Ad.

0.012 \$



1 Ad. Fiyatdır

Kablo Ucu Toplama Kılıfı
Küçük CR 802 161 0.017 \$
Kablo Ucu Toplama Kılıfı
Büyük CR 802 165 0.02 \$

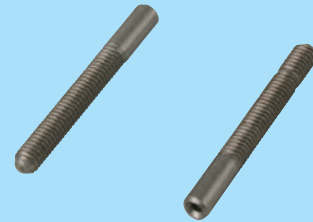

Cam Başlık Sap. (Demir) (5mm) CR 802 221 0.20 \$

Cam Başlık Sap. (Demir) (6mm) CR 802 225 0.20 \$

CONTA ÇEŞİTLERİ

TYPES OF GASKETS

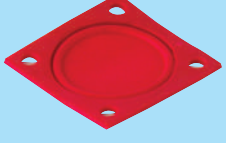

CR 803 151

Kare Şofben Contası

0.20 \$



CR 803 153

Yuvarlak Şofben Contası

0.20 \$



CR 803 155

Bombeli Yuvarlak Şofben Contası

0.20 \$



CR 803 156

Büyük Bombeli Yuvarlak Şofben Contası

0.20 \$



CR 803 158

Cemsan Veito Banyo Şofben Contası

0.20 \$



CR 803 160

Fakir Şofben Contası

0.20 \$

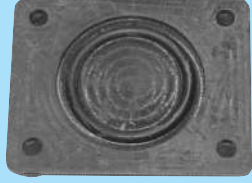

CR 803 161

Dikdörtgen Şofben Contası

0.20 \$



CR 803 163

Jumbo Şofben Contası

0.20 \$



CR 803 165

Arzum Şofben Contası

0.20 \$



CR 803 168

Şofben Contası (Hook vb.)

0.30 \$



CR 804 151

Ketil Rezistans Contası

0.55 \$



CR 804 155

Kelebek Semaver Contası

0.25 \$

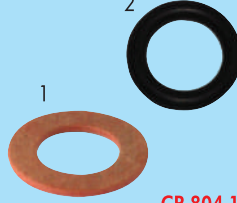

CR 804 161

Semaver (Çay Kazanı) Rezistans Contası (1.Fiber - 2 Oring)

0.04 \$



CR 804 171

Semaver Musluğu Contası

0.13 \$



CR 804 181

Radyatör Rezistans Contası

0.40 \$



CR 804 221

Yuvarlak Baymak Conta

0.55 \$



CR 804 223

Şofben Rezistans Contası

0.70 \$



CR 804 231

Oval (G5) Conta

0.60 \$



CR 804 235

Titanyum Rezistans Contası 6 Delikli

1.20 \$



CR 804 236

Titanyum 5 Delikli Conta

1.65 \$



CR 804 238

Ariston Şofben Contası

1.20 \$



CR 804 241

Ariston Şofben Contası

1.20 \$

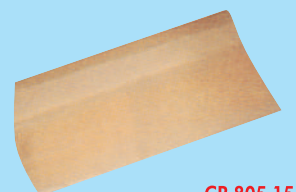

CR 805 155

Yapışkanlı Teflon Muşamba-0,13 mm (Fiyattar 1 mt. İçindir.)

26.00 \$

KLEMENS ve PORSELEN ÇEŞİTLERİ

TERMINALS AND TYPES OF PORCELAIN

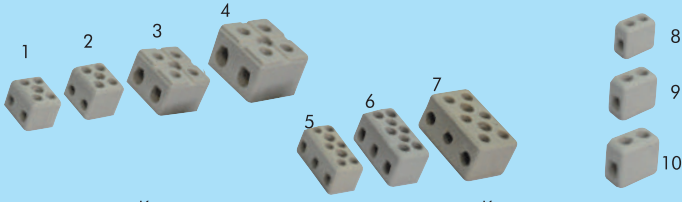

Kutu Adedi		Kutu Adedi	
1 No 2'li Por. Klm.-1	250 Ad. CR 806 151 0.45 \$	2 No 3'lü Por. Klm.-6	100 Ad. CR 806 161 0.70 \$
2 No 2'li Por. Klm.-2	150 Ad. CR 806 152 0.50 \$	3 No 3'lü Por. Klm.-7	80 Ad. CR 806 162 1.00 \$
3 No 2'li Por. Klm.-3	120 Ad. CR 806 153 0.70 \$	1 No 1'li Por. Klm.-8	400 Ad. CR 806 167 0.40 \$
4 No 2'li Por. Klm.-4	75 Ad. CR 806 154 0.90 \$	2 No 1'li Por. Klm.-9	300 Ad. CR 806 168 0.45 \$
1 No 3'lü Por. Klm.-5	200 Ad. CR 806 158 0.55 \$	3 No 1'li Por. Klm.-10	200 Ad. CR 806 171 0.60 \$



KUTU		1 Adet Fiyatıdır.	
1. No. Yanmaz Klm. (50 Ad.)	CR 807 151	0.80 \$	
2. No. Yanmaz Klm. (50 Ad.)	CR 807 152	1.00 \$	
3. No. Yanmaz Klm. (50 Ad.)	CR 807 153	1.20 \$	
4. No. Yanmaz Klm. (50 Ad.)	CR 807 154	1.50 \$	
5. No. Yanmaz Klm. (50 Ad.)	CR 807 155	1.85 \$	

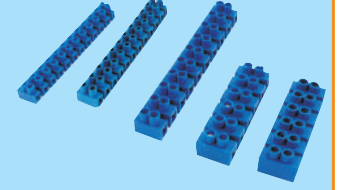

KUTU		1 Adet Fiyatıdır.	
1. No. Plastik Klm. (50 Ad.)	CR 808 151	0.75 \$	
2. No. Plastik Klm. (50 Ad.)	CR 808 152	0.85 \$	
3. No. Plastik Klm. (50 Ad.)	CR 808 153	1.10 \$	
4. No. Plastik Klm. (50 Ad.)	CR 808 154	1.45 \$	
5. No. Plastik Klm. (50 Ad.)	CR 808 155	1.75 \$	



KUTU ADEDİ			
Pls. Rekor (PG/09)	300 Ad. CR 809 151	0.22 \$	
Pls. Rekor (PG/11)	200 Ad. CR 809 153	0.27 \$	
Pls. Rekor (PG/13,5)	150 Ad. CR 809 155	0.30 \$	
Pls. Rekor (PG/16)	130 Ad. CR 809 157	0.35 \$	
Pls. Rekor (PG/21)	80 Ad. CR 809 159	0.50 \$	
Pls. Rekor (PG/29)	45 Ad. CR 809 161	0.90 \$	

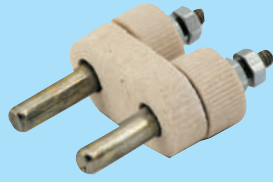

CR 810 151
Ütü Arka Taşı - Demir Ayak
(1 Torba : 100 Adet)

0.30 \$

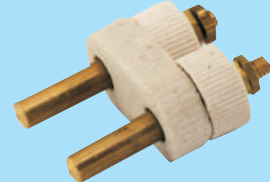

CR 810 153
Ütü Arka Taşı - Sarı Ayak
(1 Torba : 100 Adet)

0.75 \$



CR 810 155
Fiş Kovanı

0.30 \$



CR 810 165
23mm Soba Camı Başlık Kovanı
1-Düz, 2-Tek Kemerli
3-İki Kemerli

0.30 \$

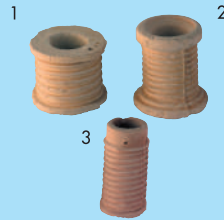

Semaver Taşları (1-2) CR 810 185 1.10 \$
Duy Taşı (3) CR 810 186 0.60 \$

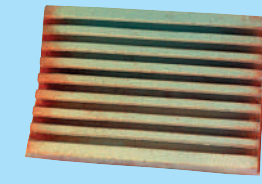

CR 810 195
8 Kanallı Fırın Taşı
(Ölçü : 18X26cm)

8.00 \$

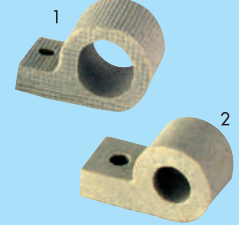

CR 810 221
Fırın Boru Salyangozu
(1) Kalın - İnce Delikli (2)

0.18 \$

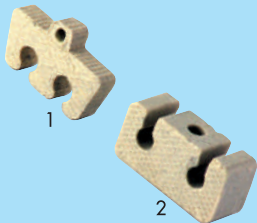

Kanca Taşı - 1 (Pors.) CR 810 225 0.17 \$
Kanca Taşı - 2 (Pors.) CR 810 227 0.22 \$



İzole Boncuk (1kg) CR 810 235 11.00 \$
00No İzole Boncuk (1kg) CR 810 245 20.00 \$



23 mm Cam Başlık Por.(1-2) CR 810 271 0.27 \$
23 mm Cam Başlık Por. (3) CR 810 281 0.06 \$



CR 810 291
10 mm Cam Başlık Pors. (No.1-2)

0.05 \$

SEMAVER MUSLUKLARI VE AKSESUARLARI

SAMOVAR'S FAUCET AND ACCESSORIES



CR 901 151

Plastik Göstergeli
Semaver Musluğu

2.50 \$



CR 901 154

Plastik Göstergesiz
Semaver Musluğu

2.50 \$



CR 901 155

Göstergesi Dıştan Dişli
Plastik Musluk

2.75 \$



CR 901 156

Dıştan Rekorlu Plastik
Semaver Musluğu
(Göstergesiz)

2.50 \$



CR 901 158

İmza - Damga
Plastik Musluk (Göstergesiz)
(Dıştan Rekorlu)

3.00 \$



CR 901 159

İmza - Damga
Plastik Musluk (Göstergeli)
(Dıştan Rekorlu)

3.00 \$



CR 901 165

İmza - Damga
Plastik Göstergesiz Musluk
Sarı Rekorlu

4.00 \$



CR 901 175

Kayalar
Plastik Musluk
Göstergesiz

5.00 \$



CR 902 150

Kır Semaver
Musluğu
(Krom)

3.50 \$

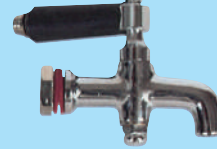

CR 902 151

Göstergesiz Küçük
Semaver Musluğu
(Krom)

3.50 \$



CR 902 152

Küçük T
Musluk İçten Dişli
Göstergesiz

7.00 \$



CR 902 155

Küçük T
Musluk İçten Dişli
Göstergeli

7.50 \$



CR 902 156

Semaver Musluğu
(Tavşan Kulağı)

4.00 \$



CR 902 158

Büyük Kahveci
Kazan Musluğu (Krom)

8.50 \$



CR 902 161

Göstergeli Büyük Kahveci
Kazan Musluğu (Krom)

9.00 \$



CR 902 165

Kahveci Kazan Musluğu
Göstergeli Dıştan Dişli

9.50 \$

SEMAVER MUSLUKLARI VE AKSESUARLARI

SAMOVAR'S FAUCET AND ACCESSORIES



CR 903 151

Göstergesiz Basmalı Semaver Musluğu (Krom)

6.00 \$



CR 903 153

Göstergeli Basmalı Semaver Musluğu (Krom)

6.50 \$



CR 903 165

3/8 İnce Rekorlu Semaver Musluğu Göstergesiz

12.00 \$



CR 903 166

3/8 İnce Rekorlu Semaver Musluğu Göstergeli

12.00 \$



CR 903 171

Kayalar Büyük Göstergesiz Musluk (Krom)

9.00 \$



CR 903 175

Kayalar Büyük Göstergeli Musluk (Krom)

10.00 \$



CR 903 181

Büyük Kahveci Kazan Musluğu (Krom) T Musluk

10.50 \$



CR 903 185

İnce Dişli T Musluk Göstergesiz

11.50 \$



CR 903 191

Kahveci T Musluk Rekor + Ayna

12.50 \$

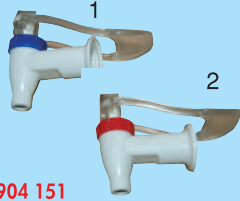

CR 904 151

Sebil Musluğu (1-2)

1.75 \$



CR 904 153

Dıştan Rekorlu Sebil Musluk (1.2)

2.20 \$



CR 904 155

Termos Musluğu

1.00 \$



CR 904 161 Semaver Musluk Tepesi (1) 1.50 \$

CR 904 165 Teknograd Mus. Tepesi (2) 1.50 \$



CR 904 171

Plastik Musluk Tepesi (Kaplama) (1 No-2 No)

1.50 \$



CR 904 178

Büyük Kayalar Musluk Tepesi

4.50 \$



CR 905 151

Semaver Tepe Contası (1-2-3)

0.60 \$

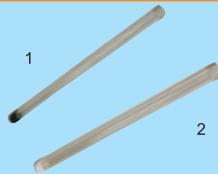

Pls. Gösterge Çubuğu (1) (Dış Çap : 12 mm)
CR 905 171 2.50 \$

Kalın Pls. Gösterge Çubuğu (2) (Dış Çap : 15 mm)
CR 905 181 3.00 \$

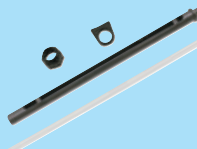

CR 905 182

Dıştan dişli Plastik Musluk Gösterge Çubuğu

2.50 \$



CR 905 191

Plastik Gösterge Tutucusu

0.35 \$

AKSESUARLAR

ACCESSORIES



CR 906 151

Silikonlu Topraklı
Ütü Fişi

30.00 \$

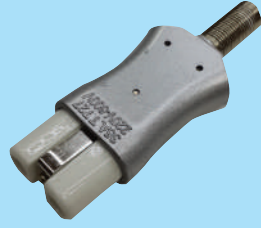

CR 907 151

Metal Topraklı Ütü Fişi
(400°C)

28.00 \$



CR 910 152

Düz Ütü Fişi (ÇINAR)

0.66 \$



CR 910 153

Yeni Düz Ütü Fişi
(Çınar)

0.68 \$



CR 910 154

Topraklı Ütü Fişi
(Çınar)

1.15 \$



CR 910 155

Topraklı Ütü Fişi
(Far)

1.60 \$



CR 910 156

Ütü Fişi Düz
(Far)

1.50 \$



CR 910 161

Anahtarlı - Işıklı - Topraklı
Erkek Fiş (1 Kutu 50 Adet)

1.90 \$



CR 910 163

Yeni Tip Anahtarlı Işıklı
Topraklı Erkek Fiş (1 Kutu 50 Ad.)

2.20 \$



Kutu / Koli

2'li Grup Priz Klm. 20/120	CR 910 165	2.60 \$
2'li Grup Priz 2mt. 12/48	CR 910 166	7.25 \$
2'li Grup Priz 3mt. 12/48	CR 910 167	8.75 \$
2'li Grup Priz 5mt. 12/48	CR 910 168	12.00 \$



Kutu / Koli

2'li Anh. Grup Priz Klm. 20/120	CR 910 171	4.30 \$
2'li Anh. Grup Priz 2mt. 12/48	CR 910 172	9.60 \$
2'li Anh. Grup Priz 3mt. 12/48	CR 910 173	11.00 \$
2'li Anh. Grup Priz 5mt. 12/48	CR 910 174	14.30 \$



Kutu / Koli

3'lü Grup Priz Klm. 20/120	CR 910 177	3.20 \$
3'lü Grup Priz 2mt. 12/48	CR 910 178	8.00 \$
3'lü Grup Priz 3mt. 12/48	CR 910 179	10.00 \$
3'lü Grup Priz 5mt. 12/48	CR 910 180	13.25 \$



Kutu / Koli

3'lü Grup Priz Klm. An. 20/120	CR 910 187	4.80 \$
3'lü Grup Priz 2mt. An. 12/48	CR 910 188	10.20 \$
3'lü Grup Priz 3mt. An. 12/48	CR 910 189	12.80 \$
3'lü Grup Priz 5mt. An. 12/48	CR 910 190	15.30 \$



Kutu / Koli

6'lı Grup Priz Klm. 15/90	CR 910 201	6.00 \$
6'lı Grup Priz 2mt. 12/48	CR 910 202	11.25 \$
6'lı Grup Priz 3mt. 12/48	CR 910 203	12.75 \$
6'lı Grup Priz 5mt. 12/48	CR 910 204	16.25 \$



Kutu / Koli

6'lı Anh. Grup Priz Klm. 15/90	CR 910 207	7.50 \$
6'lı Anh. Grup Priz 2mt. 12/48	CR 910 208	13.70 \$
6'lı Anh. Grup Priz 3mt. 12/48	CR 910 209	15.25 \$
6'lı Anh. Grup Priz 5mt. 12/48	CR 910 210	18.50 \$



CR 910 215

10'lü Grup Priz

16.00 \$

AKSESUARLAR

ACCESSORIES



CR 910 310

Sıva Altı Anahtarlı
Topraklı Priz

Kutu / Koli
15 / 150

2.25 \$



CR 910 311

Sıva Üstü
Anahtar

Kutu / Koli
20 / 200

1.40 \$



CR 910 312

Sıva Üstü
Komitatör

Kutu / Koli
20 / 200

1.55 \$



CR 910 313

Sıva Üstü Kare
Topraklı Priz

Kutu / Koli
20 / 200

1.55 \$



CR 910 321

Sıva Üstü Topraklı
Priz Yuvarlak

Kutu / Koli
20 / 200

1.70 \$



CR 910 322

Sıva Üstü Tekli
Yuvarlak Anahtar

Kutu / Koli
24 / 240

1.70 \$



CR 910 323

Sıva Üstü
Yuvarlak Komitatör

Kutu / Koli
24 / 240

1.70 \$



CR 910 325

Trifaze Fiş

Kutu / Koli
24 / 240

3.10 \$



CR 910 327

Trifaze Priz

Kutu / Koli
16 / 160

3.55 \$



CR 910 351

3'lü Anahtarlı
Golyat Nilüfer

Kutu / Koli
20 / 80

5.50 \$



CR 910 352

3'lü Fiş Priz
Delta

Kutu / Koli
20 / 120

3.55 \$



CR 910 353

3'lü Fiş Priz
Nilüfer

Kutu / Koli
24 / 144

2.75 \$



CR 910 354

3'lü Sıva Altı
Topraklı Priz

Kutu / Koli
25 / 150

3.20 \$



CR 910 355

3'lü Fiş Priz
Papatya

Kutu / Koli
20 / 120

2.60 \$



CR 910 356

2'li
Fiş Priz

Kutu / Koli
25 / 150

2.20 \$



CR 910 357

Golyat
5'li Fiş

Kutu / Koli
50 / 500

0.90 \$

AKSESUARLAR

ACCESSORIES



CR 910 362

3'lü
T Fiş

Kutu / Koli
50 / 500

0.85 \$



CR 910 365

4'lü Fiş Priz
Golyat

Kutu / Koli
20 / 80

4.60 \$



CR 910 401

Ups'li Topraklı
Erkek Fiş

Kutu / Koli
50 / 500

0.90 \$



CR 910 402

Topraklı
Dişi Fiş

Kutu / Koli
50 / 300

1.00 \$



CR 910 403

Topraklı
Erkek Fiş

Kutu / Koli
50 / 500

0.85 \$



CR 910 404

Topraklı
Dişi Fiş

Kutu / Koli
50 / 500

1.00 \$



CR 910 406

Erkek Fiş
Mimosa

Kutu / Koli
50 / 1000

0.65 \$



CR 910 408

Dişi Fiş
Mimosa

Kutu / Koli
50 / 1000

0.65 \$



CR 910 410

Monoblok Topraklı
Erkek Fiş

Kutu / Koli
50 / 500

0.85 \$



CR 910 412

Topraklı
L Fiş

Kutu / Koli
50 / 500

1.00 \$



CR 910 414

Topraklı
Kulplu Fiş

Kutu / Koli
50 / 500

1.00 \$



CR 910 416

Yassı Erkek
Fiş

Kutu / Koli
50 / 500

0.55 \$



CR 910 417

Yassı Dişi
Fiş

Kutu / Koli
50 / 500

0.55 \$



CR 910 501

1 x 16 Kauçuk
Erkek Fiş

Kutu / Koli
50 / 300

1.10 \$



CR 910 502

1 x 16 Kauçuk
Dişi Fiş

Kutu / Koli
25 / 150

1.10 \$



CR 910 504

1 x 16 Kauçuk Kulplu
Erkek Fiş

Kutu / Koli
50 / 300

1.00 \$

AKSESUARLAR

ACCESSORIES



CR 910 506

1 x 16 Monofaze Topraklı Duvar Prizi **Kutu / Koli**
18 / 108

2.25 \$



CR 910 508

1 x 16 Kauçuk Monofaze 2'li Grup Priz **Kutu / Koli**
10 / 60

3.25 \$



CR 910 510

1 x 16 Kauçuk Monofaze 3'lü Grup Priz **Kutu / Koli**
6 / 36

3.50 \$



CR 910 512

4'lü Kauçuk 1X16 Monofaze Grup Priz **Kutu / Koli**
10 / 80

4.00 \$



CR 910 515

3 x 25 Kauçuk Trifaze Fiş **Kutu / Koli**
30 / 180

2.50 \$



CR 910 517

3 x 25 Kauçuk Trifaze Priz **Kutu / Koli**
20 / 120

3.00 \$



CR 910 519

3 x 25 Kauçuk Trifaze Duvar Priz **Kutu / Koli**
16 / 96

4.50 \$



CR 911 151

Minyonet Duy
(1 Paket 100 Ad.)

0.08 \$



CR 911 152

E-14 Plastik Duy
(1 Kutu 100 Adet)

1.15 \$



CR 911 155

E-14 Donanma Duy
(1 Kutu 100 Adet)

0.75 \$



CR 911 156

E-27 Donanma Duy
(1 Kutu 50 Adet)

0.50 \$



CR 911 161

Bahçe Yağmur Duy E-27
(1 Kutu 50 Adet)

0.55 \$



CR 911 168

Bakalit Duy Priz E-27
(1 Kutu 50 Adet)

1.50 \$



CR 911 170

Duy Fiş Renkli **Kutu / Koli**
50 / 500

0.60 \$



CR 912 165

E14 / E27 Rondelalı ve Rondelasız
(Krom-Sarı Renk) Metal İtalyan Duy
(1-2-3-4-5-6-7-8 No)

2.00 \$



E-27 Bronz Duy (1) 50 Ad.

CR 912 171 1.75 \$

E-14 Bronz Duy (2) 100 Ad.

CR 912 172 1.75 \$

AKSESUARLAR

ACCESSORIES



E-27 İtalyan Duy-1
CR 912 175 0.60 \$

E-14 İtalyan Duy-2
CR 912 176 0.60 \$



E-14 Beyaz Avize Duy (1)
CR 912 181 0.60 \$

E-14 Beyaz Avize Duy (2)
CR 912 182 0.60 \$



E-27 Beyaz Avize Duy (1)
CR 912 183 0.60 \$

E-27 Beyaz Avize Duy (2)
CR 912 184 0.60 \$

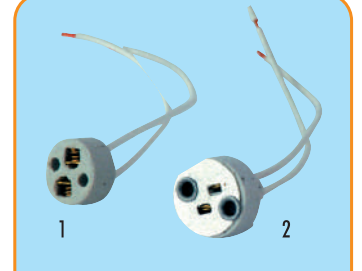

1) 12/50 Spot Duy Açık
CR 913 151 0.55 \$

2) 12/50 Spot Duy Plakalı
CR 913 152 0.60 \$

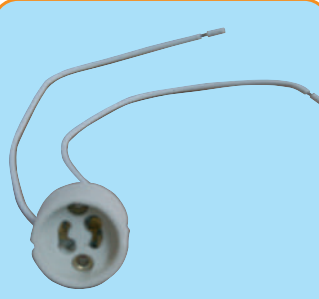

CR 913 159

Porselen Starter Duy

0.65 \$



CR 913 175

Korunmalı Askılı Porselen Duy
(1 Kutu 50 Adet)

0.90 \$



CR 913 185

Asma Duy (Bakalit)
1 Kutu 50 Adet

0.50 \$



CR 913 191

Duvar Duy E-27
(1 Kutu 20 Adet)

0.70 \$



CR 913 192

Tavan Duy E-27
(1 Kutu 20 Adet)

0.70 \$



CR 913 195

Duvar Glop Dibi E-27
(1 Kutu 12Adet)

0.90 \$



CR 913 196

Tavan Glop Dibi E-27
(1 Kutu 12 Adet)

0.90 \$



CR 913 215

Plastik Sarkıt Duy Kablı Uzunluğu
60 cm (Renkleri Beyaz-Siyah) E-27

1.30 \$



CR 913 255

Duy Dönüştürücü
E 14 / 27

3.75 \$



CR 913 256

Duy Dönüştürücü
E 27 / 14

4.00 \$



CR 913 261

Üçlü Duy Set
E-27

1.90 \$



CR 913 265

Anahtarlı Duy Fiş

1.20 \$

AKSESUARLAR

ACCESSORIES

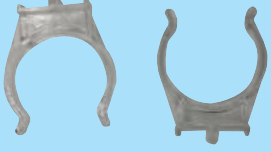

CR 913 271

Floresant Ay Ayak

0.06 \$



CR 913 301

Arapuar Plastik
(1 Kutu 50 Ad.)

0.60 \$



CR 913 305

Çift Çıtlı Ara Puar
(1 Kutu 50 Ad.)

0.50 \$



CR 913 315

Ara Puar
(1 Kutu 50 Ad.)

0.50 \$



CR 915 151

Globe İzole Bant
(1 Paket : 10 Ad./1 Koli : 500 Ad.)

0.65 \$



CR 915 155

Giner İzole Bant
1 Koli 500 Adet

0.60 \$



CR 915 159

Geniş Globe Bant
50 mm

10.00 \$



CR 915 161

Alevalmaz Bant
5 cm (19x25)

3.30 \$



CR 915 165

Teflon Bant

0.60 \$



CR 915 167

Eriyen Bant

2.60 \$

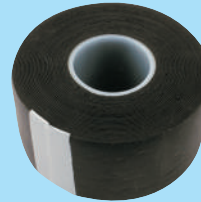

CR 915 169

Geniş Eriyen Bant
Ölçü : 50 mmx0,18x8 mt

7.50 \$



CR 915 175

Çift Taraflı Bant

0.50 \$



CR 915 177

Şeffaf Silikon
Çift Taraflı Bant

1.10 \$



CR 915 181

Koli Bandı (100 Mt)
(Koli Adedi : Değişken)

2.75 \$



CR 916 151

Teflon Ütü Çarığı

9.00 \$



CR 916 161

Alüminyum Ütü Çarığı

9.00 \$

AKSESUARLAR ACCESSORIES

Beyaz - Siyah
Renk Beliriniz



1 Paket

CR 917 153	150x3.6mm. Kablo Bağı	100	1.35 \$
CR 917 155	200x2.5mm. Kablo Bağı	100	1.90 \$
CR 917 157	200x3.6mm. Kablo Bağı	100	3.00 \$
CR 917 158	250x3.6mm. Kablo Bağı	100	3.50 \$
CR 917 161	300x3.6mm. Kablo Bağı	100	4.65 \$
CR 917 163	380x4.8mm. Kablo Bağı	100	8.00 \$
CR 917 166	450x7.6mm. Kablo Bağı	100	16.50 \$

100 Adet Fiyatdır.



CR 917 181	19x19mm. Kab. Bağı Tutucu (100 Ad.)	0.05 \$
CR 917 185	28x28mm. Kab. Bağı Tutucu (100 Ad.)	0.06 \$

1 Adet Fiyatdır.



Çelik Takviyeli

CR 918 151	10 mt. Plastik Susta	4.00 \$
CR 918 152	15 mt. Plastik Susta	6.50 \$
CR 918 153	20 mt. Plastik Susta	8.50 \$
CR 918 154	25 mt. Plastik Susta	10.50 \$
CR 918 155	30 mt. Plastik Susta	12.50 \$



Çelik Takviyeli

CR 918 164	10 mt. Çelik Susta	8.50 \$
CR 918 165	15 mt. Çelik Susta	12.50 \$
CR 918 166	20 mt. Çelik Susta	16.50 \$
CR 918 167	25 mt. Çelik Susta	21.00 \$
CR 918 168	30 mt. Çelik Susta	25.00 \$



CR 918 225

Japon Yapıştırıcı
10 gr. Büyük Boy

1.10 \$



CR 918 227

Spreyli Hızlı Yapıştırıcı
Kaliteli

5.00 \$



CR 918 229

WD-40 Pas Sökücü
200 mm.

8.00 \$



Çivili Kroşe

	No.	Kutu	Amb.	Koli	
CR 918 410	0	100	1000	40.000	0.011 \$
CR 918 411	1	100	1000	40.000	0.011 \$
CR 918 412	2	100	1000	40.000	0.011 \$
CR 918 413	3	100	1000	24.000	0.013 \$
CR 918 414	4	100	1000	24.000	0.013 \$
CR 918 415	5	100	1000	20.000	0.016 \$
CR 918 416	6	100	1000	18.000	0.016 \$
CR 918 417	7	100	1000	10.000	0.035 \$
CR 918 418	8	100	500	5.000	0.050 \$
CR 918 419	9	50	500	5.000	0.060 \$

1 Adet Fiyatdır

BİLGİSAYAR FAN MOTORLARI
220 V



CR 919 182	12x12x38	220V	10.00 \$
CR 919 183	12x12x25	220V	10.00 \$
CR 919 184	9x9x38	220V	10.00 \$
CR 919 185	9x9x25	220V	10.00 \$
CR 919 186	8x8x38	220V	10.00 \$
CR 919 187	8x8x25	220V	10.00 \$

BİLGİSAYAR FAN MOTORLARI
24 V



CR 919 201	12x12x38	24V	9.50 \$
CR 919 202	12x12x25	24V	6.00 \$
CR 919 204	9x9x25	24V	3.00 \$
CR 919 206	8x8x25	24V	3.00 \$
CR 919 207	6x6x25	24V	3.00 \$
CR 919 208	5x5x10	24V	3.00 \$

BİLGİSAYAR FAN MOTORLARI
12 V



CR 919 221	12x12x38	12V	8.00 \$
CR 919 222	12x12x25	12V	6.00 \$
CR 919 224	9x9x25	12V	3.00 \$
CR 919 226	8x8x25	12V	3.00 \$
CR 919 227	7x7x15	12V	3.00 \$
CR 919 228	6x6x25	12V	3.00 \$
CR 919 229	5x5x10	12V	3.00 \$

AKSESUARLAR

ACCESSORIES



Banyo ve Mutfak Aspiratörleri

100'lük	CR 919 241	9.50 \$
120'lük	CR 919 242	10.00 \$
150'lük	CR 919 243	13.00 \$
200'lük	CR 919 244	26.00 \$

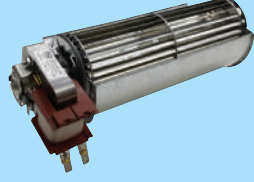

CR 919 251

Fan Motoru

20.00 \$



CR 919 261

Mikro Dalga
Fırın Motoru

6.00 \$



CR 919 265 10'lük Paket

Mikro Dalga Cam Sigortası
0,8 A (Boy : 4 cm.)

Adet Fiyatı 1.00 \$



CR 919 271

Piliç Çevirme
Motoru 4W

4.00 \$

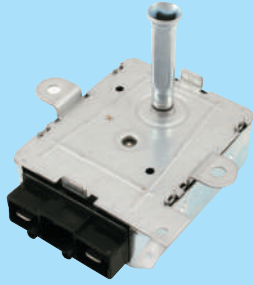

CR 919 273

Piliç Çevirme
Motoru 6W

4.50 \$



CR 919 291

Zaman Saati (Timer)
(90 Dakika)

4.00 \$



CR 919 292

Zaman Saati (Timer)
(120 Dakika)

4.50 \$



CR 919 297

Priz Tipi Mekanik
Zaman Saati

13.00 \$



CR 919 299

Akım Korumalı
Priz

6.00 \$



CR 919 301

Saç Kurutma
Makina Motoru

4.00 \$



CR 919 318

4 Kanatlı Saç Kurutma
Pervanesi Çapı : 60 mm

1.80 \$



CR 919 321

Orjinal 4 Kanatlı Şeffaf Pervane
Çapı : 60 mm (Sessiz Çalışır)
Braun Marka

3.00 \$



CR 919 325

7 Kanatlı Saç Kurutma
Pervanesi Çapı : 60 mm

1.50 \$



CR 919 331

9 Kanatlı Saç Kurutma
Pervanesi Çapı : 65 mm

1.50 \$



CR 920 151

Cam Kesme Aparatı
(El Tipi)

11.00 \$

AKSESUARLAR

ACCESSORIES



CR 920 155

Mini Matkap Tipi Cam Elması
Çap : 5 cm

5.00 \$



CR 920 157

Matkap ve Taşmotoru Tipi
Cam Elması Çap : 10 cm.

25.00 \$

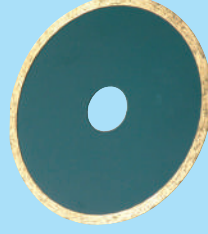

CR 920 159

Taşmotoru Tipi Cam Elması
Çap : 15 cm.

55.00 \$



CR 920 162

Cam Elmas
Mili

3.00 \$



CR 920 175

Plastik Falçata

0.85 \$



CR 920 177

Metal Falçata

1.70 \$

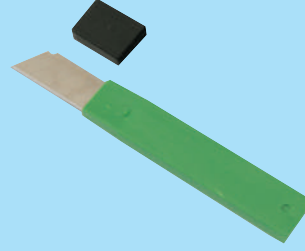

CR 920 179

Falçata Bıçağı
1 Paket 10 Adet Fiyatıdır.

2.00 \$



CR 921 151

Plastik Musluk Rekoru

0.90 \$

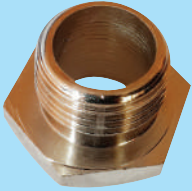

CR 921 161

Kayalar Musluk Rekoru

1.60 \$



CR 921 171

Kahveci Kazan Musluk Rekoru

1.40 \$



CR 921 175

12x1 - 3/8 Musluk Küçültme
Büyültme Nipel

2.50 \$



CR 921 181

Kısa Semaver
Dirseği

3.00 \$

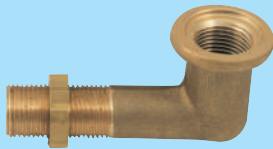

CR 921 182

Orta Semaver
Dirseği

3.00 \$

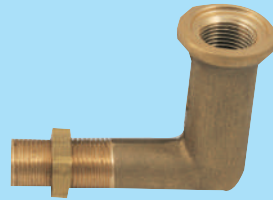

CR 921 183

Uzun Semaver
Dirseği

3.00 \$

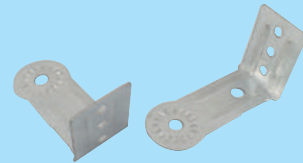

CR 922 111

İnfrared Soba
L Demiri

0.60 \$

NOTLAR

NOTES

A large white rounded rectangle with a light blue border, containing 25 horizontal lines for writing notes. The lines are evenly spaced and extend across the width of the rectangle.

NOTLAR

NOTES

A large white rounded rectangle with a light blue border, containing 25 horizontal lines for writing notes. The lines are evenly spaced and extend across the width of the rectangle.



Merkez : Büyükhendek Caddesi Ersoy Pasajı No. 25/37
Kuledibi - Beyoğlu 34421 İSTANBUL
Tel : 0212 252 15 56
cetinler@cetinlerrezistans.com
www.cetinlerrezistans.com

